



Measurement Engineering for Restaurants, Catering and Supermarkets





Testo measuring instruments – The important ingredient for good food

Of course your customers expect from you food products which are fresh and food which is prepared with care and is wholesome. To achieve this, ambient conditions on display surfaces, in refrigerated cabinets and storage rooms must be monitored along with the temperatures of cooking units or the condition of the oil in a deep-fat fryer.

Testo is here to help you with all your measurement tasks. We make a point of following closely all the latest developments in the monitoring of foodstuffs. In this way, we are always in a position to offer up-to-date solutions optimised to suit your applications. It's no wonder that tens of thousands of Testo instruments are used regularly by supermarkets, food specialist stores, restaurants and catering services.

Measurement solutions for field use

The freshness of food products and the digestibility of food is difficult to judge. Measurements can help you make decisions. The procedures are usually time-consuming and often can only be carried out in the laboratory. Testo offers user-friendly measurement engineering solutions suitable for daily use. One good example are the new pH probes which work with a gel electrolyte as a reference medium for pH measurement and, unlike conventional sensors, are leak-proof, maintenance-free and

not affected by dust and dirt particles. A real highlight is the electronic cooking oil tester which provides you with reliable information within seconds about the state of the oil in a hot deep-fat fryer. The advantage for you is that you can determine the flavour of your deep-fried food and also use cooking oil sparingly. Analysis of the state of the oil based on polarisable substances is recognised internationally but has been mainly carried out in laboratories up to now or was determined via test sets for which replacements had to be purchased.

Fully reliable and efficient

Measuring instruments must be accurate at all times. We offer you well-engineered instruments which have not only been subjected to stringent tests during the development phase but have undergone comprehensive year long field tests prior to being released on the market. The instruments also have to be calibrated to ensure food safety. Calibration should be carried out annually to augment legal certainty. Our calibration laboratories are held in high esteem internationally and are also approved for calibrations on behalf of the Deutschen Kalibrierdienstes (DKD=German Calibration Service).

Documenting parameters systematically

You have to document your measurements so that they are verifiable. Many of Testo's instruments can be read out with a practical fast printer via infrared. Measurement data is documented practically automatically. The data in our dataloggers, with which you can record temperatures and air humidity in storerooms, freezers or display surfaces, for example, can also be collected by a „data collector“ and then sent to a PC. A convenient method to collect data from different sites.

Better measurements with better equipment

Often, it is the right accessory which makes a measurement engineering solution complete. Testo offers a wide range of accessories for its instruments which, in turn, helps you to complete your measurement tasks efficiently. The range extends from numerous different probe types and designs, optional wireless or conventional probes via a fast printer and data collector to a dishwasher-safe TopSafe protection case with which you can protect your instrument from dirt, impact and moisture.

Learning changes

What was that again – who has to measure with calibrated measuring instruments? What exactly is the connection between germ multiplication and temperature?

If you need answers to the above questions, just give us a call. We will do our best to answer them.

Top engineering for first class products



Horst Zahner,
Managing Director
and Company
founder,
Traiteur GmbH,
Freiburg, Germany

Zahner Traiteur GmbH in Freiburg, Germany was founded in the year 1970 and over the years has developed into a modern production business in the food sector. The high levels of product warranty, reliability and quality have been consistently improved on over the past 30 years of the company's existence. The company is one of the most renowned in the delicatessen and catering segment. More than 90 employees work to supply top products on a daily basis. 36 small haulage contractors are responsible for delivering prepared goods every day.

We spoke to Managing Director and Company founder Horst Zahner:

„You cannot compromise on quality – we cannot just sign and that's it – we live it every day with our whole team; regardless of whether it is catering, delicatessen dishes, party service or our fresh pasta.

Closed quality assurance systems, which can be documented, are an indispensable requisite for our continued market success. We recognised at an early stage that Testo speaks our language exactly. No other supplier offers the range of products and this level of efficiency. As you can imagine, in our business not only is highest quality important, punctuality and speed are also top priorities and Testo's product line accommodates us with user-friendly operation, manageability and robustness. Now, that's what I call field-oriented measurement engineering.

By the way, the ever resourceful Testo developers really hit the mark with their logger systems. Now we can monitor transport of our highly sensitive products non-stop; nothing is left to chance and documentation of the measurement data just couldn't be easier.

Over the last few years, we have started sending our employees regularly to Testo for training. Not only do we gain important insights into the optimum use of Testo measurement engineering, but we also learn how we can quickly adapt to the latest legal requirements.

That's what I call all-inclusive – Keep up the good work Testo – after all, we quality fanatics have to stick together...“



Exactly the right instrument



for every requirement



Temperature measurement – fast and easy

Mini thermometer

The quick-action immersion/penetration thermometer is ideal for measuring the temperature in air, soft or powdery substances and liquids.

The surface thermometer has a widened measurement tip especially for surface measurements.

- Easy to read thanks to large display
- Can be used anywhere

Mini thermometer 1

up to +150 °C, length 133 mm

Part no. 0560 1110

Mini thermometer 2

up to +250 °C, length 213 mm

Part no. 0560 1111

Mini surface thermometer 3

up to +300 °C, length 120 mm

Part no. 0560 1109

1 + 2

Immersion/penetration probe Ø 3.5 mm

3

Surface temperature probe with widened measurement tip Ø 15 mm, robust design

Technical data	1	2	3
Meas. range	-50 to +150 °C	-50 to +250 °C	-50 to +300 °C
Accuracy ±1 digit	±1 °C (-10 to +99.9 °C) ±2 °C (-30 to -10.1 °C) ±2% of mv (+100 to +150 °C)	±1 °C (-10 to +99.9 °C) ±2% of mv (+100 to +199.9 °C) ±3% of mv (+200 to +250 °C)	±1 °C (-30 to +250 °C) ±2 °C (remaining range)
Resolution	0.1 °C (-19.9 to +150 °C) 1 °C (remaining range)	0.1 °C (-19.9 to +199.9 °C) 1 °C (remaining range)	0.1 °C (-19.9 to +199.9 °C) 1 °C (remaining range)
Oper. temp.	-10 to +50 °C	-10 to +50 °C	-10 to +50 °C



Fast spot check measurements

Accessories Ordering data Part no.

Button cell batteries, Type LR 44, 1.5 Volt (4 off) 0515 0032

Temperature measurement - accurate and super-fast

testo 905-T1

One of the fastest penetration thermometers, with a broad measurement range and high accuracy

testo 905-T1 1

testo 905-T1: penetration thermometer incl. attachment clip, battery

Part no. 0560 9055

testo 905-T2

The surface thermometer in professional quality with a sprung thermocouple measurement head, very fast reaction time and high accuracy.

testo 905-T2 2

testo 905-T2: surface thermometer with cross-band probe, incl. attachment clip, battery

Part no. 0560 9056

Technical data	1	2
Meas. range	-50 to +350 °C Short-term to +500 °C	-50 to +350 °C Short-term to +500 °C
Accuracy ±1 digit	±1 °C (-50 to +99.9 °C) ±1% of mv (remaining range)	±(1 °C ±1% of mv)
Resolution	0.1 °C	Battery life 1000 h
Oper. temp.	0 to +40 °C	Storage temp. -20 to +70 °C

Accessories testo 905-T1 Part no.

ISO calibration certificate/temperature, for air/immersion probes, calibration points -18°C; 0°C; +60°C 0520 0001

Accessories testo 905-T2 Part no.

ISO calibration certificate/temperature, meas. instr. with surface probe; calibration points +60°C; +120°C; +180°C 0520 0071

1

testo 905-T1: Immersion/penetration probe, Ø 3mm with pro sensor (thermocouple Type K)

2

testo 905-T2: sprung thermocouple cross-band Ø 12 mm adapts to any surface



Checking hotplates and griddles

Temperature measurement – fast and easy

Waterproof mini thermometer

Fast spot check temperature measurement with the watertight mini thermometer is an important topic in the the food sector.

Thanks to the large, easily legible display, temperature checks are possible even under bad light conditions.

- Easy to read thanks to large display
- Can be used anywhere

Waterproof mini thermometer

up to +230 °C, length 133 mm,
Protective sleeve for probe shaft

Part no. 0560 1112

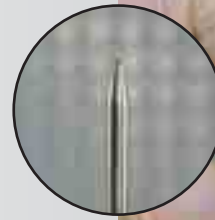

Immersion/penetration probe, Ø 3.5 mm



Spot checks at a food counter

Technical data	
Meas. range	-40 to +230 °C
Accuracy ±1 digit	±1 °C (-20 to +99.9 °C) ±2% of mv (+100 to +199.9 °C) ±3% of mv(+200 to +230 °C)
Resolution	0.1 °C (-19.9 to +199.9 °C) 1 °C (remaining range)
Oper. temp.	-10 to +50 °C

Accessories Ordering data	Part no.
Button cell batteries, Type LR 44, 1.5 Volt (4 off)	0515 0032

Ambient condition measurements - versatile and easy

testo 605-H1

The thermo-hygrometer you can bend. Small, compact and accurate. The long-term stable sensor guarantees correct measurement results even after years.

- Dewpoint calculation from -20 to +50 °Ctd
- Long-term stable Testo humidity sensor
- Ideal for measurements in ducts
- Display can be angled for easy readout of measurement values

testo 605-H1

testo 605-H1: thermohygrometer with duct holder, incl. attachment clip and battery

Part no. 0560 6053

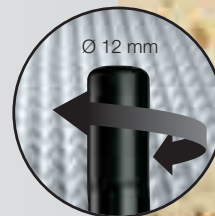

Sensor protection due to rotatable protective cap, probe shaft 125 mm long



With flexible joint

Monitoring air humidity

Technical data			
Meas. range	+5 to +95 %RH 0 to +50 °C -20 to +50 °C td		
Accuracy ±1 digit	±3 %RH / ±0.5 °C		
Resolution	0.1 %RH / 0.1 °C	Battery life	Approx. 1000 h
Oper. temp.	0 to +50 °C	Storage temp.	-20 to +70 °C

Accessories Ordering data	Part no.
ISO calibration certificate/humidity, Calibration point 75.3%RH at +25°C	0520 0096
ISO calibration certificate humidity, Calibration points 11.3 %RH and 75.3 %RH at +25°C	0520 0006



Core thermometer – fast and robust

Do you manage to get home by 5pm every day?



Axel Rieple,
Head of Sales,
Germany

Probably not, because your job expects above-average dedication. You also need partners who won't let you down. We are leading the way with our quality service. Check it out for yourself.

Do you need an accessory, do you have a question about measuring or do you need a replacement instrument? – Testo Service employees are at your service when you need them. Good to know when the situation requires.



TopSafe, waterproof and dishwasher-safe protective case (IP 67)



Almost invisible penetration hole due to special food probe



Audible and optical alarm (LED lights up)



Set accessories

- 1 TopSafe
- 2 Probe protecting cap
- 3 Practical belt-clip



Core thermometer – fast and robust

testo 106

The core thermometer testo 106 with a thin, robust measuring tip, excellently suited for fast core temperature checks

- Automatic recognition of final value (Auto-Hold)



Only in combination with TopSafe

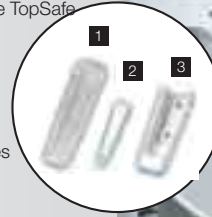

Accessories Ordering data	Part no.
TopSafe (indestructible protection case), waterproof and dishwasher-safe protection case (IP67)	0516 8265
Frozen food drill, loss-proof attachment to belt clip	0554 0826
Holding clip with probe protection cap	0554 0825
ISO calibration certificate/temperature, for air/immersion probes, calibration point +60°C	0520 0063
ISO calibration certificate/temperature, for air/immersion probes, calibration point -18°C	0520 0061
ISO calibration certificate/temperature, for air/immersion probes, calibration point 0°C	0520 0062
ISO calibration certificate/temperature, for air/immersion probes, calibration points -18°C; 0°C	0520 0041
ISO calibration certificate/temperature, for air/immersion probes, calibration points -8°C; 0°C; +40°C	0520 0181

Waterproof and protected from impact with protective case TopSafe

Set accessories

- 1 TopSafe
- 2 Probe protecting cap
- 3 Practical belt-clip

Checking the correct temperature of sensitive foodstuffs, e.g. fish

testo 106

testo 106, core thermometer incl. probe protecting cap and battery

Part no. 0560 1063

Set testo 106

Set testo 106, core thermometer incl. TopSafe (waterproof protective case, IP 67), belt clip, probe protecting cover and battery

Part no. 0563 1063

Technical data

Meas. range	-50 to +275 °C		
Accuracy	±1 % of mv (+100 to +275 °C) ±1 digit	±1 °C (-50 to -30.1 °C)	
Resolution	0.1 °C	Battery life	350 h
Oper. temp.	-20 to +50 °C	Dimensions	215 x 34 x 19 mm
Storage temp.	-40 to +70 °C	Weight	80 g

Robust one-hand thermometer – With interchangeable measurement tips

testo 105

The robust food thermometer with interchangeable measurement tips for control measurements in abattoirs, refrigerated storerooms, lorries etc.

testo 105

One-hand thermometer with standard measurement tip, incl. battery

Part no. 0563 1051

Technical data

Probe type	NTC
Meas. range	-50 to +275 °C
Accuracy	±0.5 °C (-20 to +100 °C) ±1 digit ±1 °C (-50 to -20.1 °C) ±1 % of mv (+100.1 to +275 °C)
Resolution	0.1 °C
Storage temp.	-40 to +70 °C
Oper. temp.	-20 to +50 °C
Battery type	4 x Button cell LR44
Auto Off	10 min
Protection class	IP65
Dimensions	145 x 38 x 195 mm
Weight	139 g

- 2 user-defined limit values, visual or audible alarm
- Built-in display illumination
- Audible key feedback
- 1 line display
- Waterproof (IP 65) and robust

Accessories Ordering data

Standard measurement tip, 100 mm long
Part no. 0613 1051

Frozen food tip, 90 mm long

Part no. 0613 1052

Long measurement tip, 200 mm long

Part no. 0613 1053

Aluminium case for the testo 105 one-hand thermometer and accessories

Part no. 0554 1051

Button cell batteries, Type LR 44, 1.5 Volt (4 off)

Part no. 0515 0032

ISO calibration certificate/temperature, for air/immersion probes, calibration points -18°C; 0°C

Part no. 0520 0041

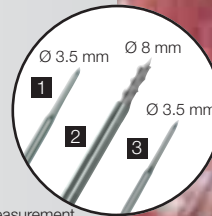

- 1 Standard measurement tip 100 mm
- 2 Frozen food tip 90 mm
- 3 Long measurement tip 200 mm



Easy-to-change measurement tips

Measuring core temperature on delivery of fresh meat

testo 105 with frozen food measurement tip

testo 105 with frozen food measurement tip, belt/wall holder and batteries

Part no. 0563 1054

Complete case

One-hand thermometer with standard measurement tip, frozen food tip, long measurement tip and belt/wall holder in aluminium case

Part no. 0563 1052

Mini thermometer – With penetration probe

Mini thermometer

The affordable mini thermometer with Min/Max alarm. Small in size but big on quality! The penetration probe is attached to the instrument (80 cm cable) and is suitable for measuring the temperature in air, in soft powdery substances and in liquids.

- Securely attached probe
- Adjustable Min/Max alarm
- Integrated clip for attachment to clothing, wall, placing in position

Mini thermometer

Mini thermometer, battery included

Part no. 0900 0530

Ordering data/Quantity discount	Part no.
Mini thermometer, from 5 off	
Mini thermometer, from 10 off	
Mini thermometer, from 25 off	
Mini thermometer, from 50 off	
ISO calibration certificate/temperature, for air/immersion probes, calibration point -18°C	0520 0061
ISO calibration certificate/temperature, for air/immersion probes, calibration point 0°C	0520 0062

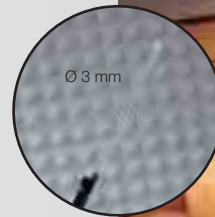

Securely attached penetration probe, 80 cm probe cable, probe pipe 190 mm long



Routine checks on cheese counters

Technical data

Meas. range	-50 to +150 °C	Oper. temp.	0 to +50 °C
Accuracy	±1 °C (-10 to +100 °C)	Storage temp.	-20 to +70 °C
±1 digit	±2 °C (remaining range)	Battery life	100 h
Resolution	0.1 °C (-19.9 to +150 °C)	Battery type	2 AAA micro batteries
	1 °C (-50 to -20 °C)		

Temperature clock indicators

testoterm clock indicators

testoterm clock indicators are self-adhesive, temperature-resistant foils with heat-sensitive elements to monitor temperature.

- Practical booklet with 10 clock indicators
- Clock indicators available on sheets from 5000 off (100 sheets of 50 off)



Actual size
Irreversible change in colour within 2 seconds

testoterm clock indicators

testoterm clock indicators	Ordering data/Quantity discount
+40 to +54 °C Part no. 0646 0071	1 to 4 booklets (with 10 each)
+60 to +82 °C Part no. 0646 0072	5 to 9 booklets (with 10 each)
+88 to +110 °C Part no. 0646 0073	10 to 19 booklets (with 10 each)
+116 to +138 °C Part no. 0646 0074	20 to 49 booklets (with 10 each)
+143 to +166 °C Part no. 0646 0075	50 to 99 booklets (with 10 each)
+171 to +193 °C Part no. 0646 0076	1000 on sheets of 50 (Minimum quantity 5000 off)
+199 to +224 °C Part no. 0646 0077	
+232 to +260 °C Part no. 0646 0078	



Monitoring temperature in cooking or smoking cabinets

Technical data

Accuracy: from +43 °C to +154 °C: ±1.5 °C; from +160 °C: ±1% ±1 °C of respective temperature value
Maximum operating temperature: corresponding to respective measuring ranges
Storage of clock indicators: up to +65 °C: max. 9 months;
remaining measuring ranges up to 2 years; max. storage temperature +25 °C.
Storage in refrigerator recommended.

Thermometer strips – Convenient and reliable

testoterm strips

testoterm thermometer strips are self-adhesive foils with temperature sensitive elements for temperature control and regulation e.g. monitoring batches during cooking.

- +37 to +280 °C
 - Thermometer strips available on rolls (e.g. for labelling machines) from a minimum order quantity of 5000 off.
- Ordering options:
1 roll of 5000 off
5 rolls of 1000 off

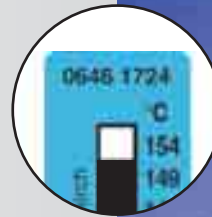

Irreversible change in colour within 2 seconds



Practical booklet with 10 thermometer strips

Checks temperature in warehouses, during transport...

testoterm strips

+37 to +65 °C

Part no. 0646 0108

+71 to +110 °C

Part no. 0646 0916

+116 to +154 °C

Part no. 0646 1724

+161 to +204 °C

Part no. 0646 2532

+204 to +260 °C

Part no. 0646 3341

+249 to +280 °C

Part no. 0646 0005

Ordering data/Quantity discount

- 1 to 4 booklets (with 10 each)
- 5 to 9 booklets (with 10 each)
- 10 to 19 booklets (with 10 each)
- 20 to 49 booklets (with 10 each)
- 50 to 99 booklets (with 10 each)
- 1000 on a roll (minimum quantity 5000 off)
- 5000 on a roll
- Ordering option for 5000 off:
1 roll of 5000 off
5 rolls of 1000 off
- Further rolls of 1000 can be ordered

Technical data

Same as temperature single indicators, see below

Dimensions l x w: 50 x 18 mm or 39 x 18 mm

Temperature single indicators – Convenient and reliable

Single indicators

testoterm single indicators are self-adhesive temperature sensitive foils with elements to check a given maximum temperature.

- +43 to +199 °C
- Practical single indicator booklet
- Single indicators on rolls or sheets available from a minimum order quantity of 5000 off.

Ordering data/Quantity discount

- 1 to 4 booklets (with 50 each)
- 5 to 9 booklets (with 50 each)
- 10 to 19 booklets (with 50 each)
- 20 to 49 booklets (with 50 each)
- 50 to 99 booklets (with 50 each)

- 5000 on sheets on sheets or rolls
- Ordering options for rolls
1 roll of 5000 off
5 rolls of 1000 off

In stock:
71 °C, 77 °C, 82 °C, 110 °C, 143 °C

For all additional single indicators (46/49/54/60/65/88/93/99/104/116/121/127/132/138/149/154/166/177/182/188/193/199/204/210/216/224/232/241/249/254/260 °C) the following applies: Delivery time of 6 weeks for minimum order of 10 booklets.



Irreversible change in colour within 2 seconds

Charge slip

Blank no.

No. of boiling process

Chamber no.

Beg./End of procedure

Final temperature

15.3.04

384

17

3

3^h / 17^h

104 °C

Temperature control, for example, during storage, transport, when analysing damage etc.

Single indicators

Measuring range: +46°C to +199°C

Part no. 0646 1... (...=reading)

Ordering examples:

Single indicator: +46°C: 0646 1046

Single indicator: +199°C: 0646 1199

Technical data

Accuracy: From +46 °C to +154 °C: ±1.5 °C; from +160 °C: ±1% ± 1°C of respective reading

Max. operating temperature corresponds to the respective measuring ranges

Dimensions l x w: 15 x 14 mm

Storage of single indicators: Up to +65 °C: max. 9 months; other measuring ranges up to 2 years; max. storage temperature +25 °C. Storage in a refrigerator is recommended.

Temperature monitoring – Highly accurate

testo 110

The highly accurate, versatile testo 110 temperature measuring instrument is ideal for the food sector on account of its optional TopSafe protection case. The engineering used is specially designed for applications in refrigerated store rooms and cabinets and for outdoors.

In addition to the wide range of conventional probes available with cable, a wireless radio probe can be used simultaneously (if radio module is used in instrument).

- Wireless measurement with radio probes possible (optional)
- Audible alarm (adjustable alarm limits)
- Displays max/min readings in 2 line, backlit display

Measurement data printout on site on Testo fast printer (optional)



Only in combination with TopSafe

testo 110

testo 110, 1 channel temperature measuring instrument NTC, audible alarm, connection to an optional radio probe, with battery and calibration protocol

Part no. 0560 1108

Printer and Accessories

Printer and Accessories	Part no.
Testo fast printer with wireless infrared interface, 1 roll thermal paper and 4 AA batteries	0554 0549
Spare thermal paper for printer (6 rolls), measurement data documentation legible for up to 10 years	0554 0568
Spare thermal paper for printer (6 rolls)	0554 0569

External fast charger for 1-4 AA rech. batteries, incl. 4 Ni-MH rech. batteries with individual cell charging and charge control display, incl. impulse trickle charging, integrated discharge function, with built-in international mains plug, 100-240 V, 300 mA, 50/60 Hz	0554 0610
--	-----------

Additional accessories

Additional accessories	Part no.
9V rech. battery for instrument, instead of battery	0515 0025
Recharger for 9V rechargeable battery, for external recharging of 0515 0025 battery	0554 0025
Lithium battery, button cell, type CR 2032 for wireless probes	0515 0028

Transport and Protection

Transport and Protection	Part no.
TopSafe, protects from impact and dirt	0516 0221
Case for measuring instrument and probes	0516 0210
Transport case for meas. instr. and probes (405 x 170 x 85 mm)	0516 0201
Transport case for measuring instrument, 3 probes and accessories (430 x 310 x 85 mm)	0516 0200

Calibration Certificates

Calibration Certificates	Part no.
ISO calibration certificate/temperature, for air/immersion probes, calibration points -18°C; 0°C; +60°C	0520 0001
DKD calibration certificate/temperature, meas. instr. with air/immersion probe; calibration points -20°C; 0°C; +60°C	0520 0211
ISO calibration certificate/temperature, single point calibration for surface thermometer; calibration point +60°C	0520 0072
ISO calibration certificate/temperature, single point calibration for surface thermometer; calibration point +120°C	0520 0073

* TopSafe: TPU casing; TPE lid; PC stand



Inspects a refrigerated counter for sufficient refrigeration power



TopSafe, the indestructible protective case (optional)



Checks incoming goods, no annoying cables thanks to radio probe





Recommended Set: testo 110 – Starter set

testo 110, 1 channel temperature measuring instrument NTC, audible alarm, connection to an optional radio probe, with battery and calibration protocol	0560 1108
TopSafe, protects from impact and dirt	0516 0221
Waterproof NTC immersion/penetration probe	0613 1212
Transport case for meas. instr. and probes (405 x 170 x 85 mm)	0516 0201

Technical data

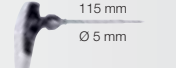
Probe type	NTC
Meas. range	-50 to +150 °C
Accuracy ±1 digit	±0.2 °C (-20 to +80 °C) ±0.3 °C (remaining range)
Resolution	0.1 °C
Oper. temp.	-20 to +50 °C
Storage temp.	-40 to +70 °C
Battery type	9V block battery, 6F22
Battery life	200 h (connected probe, backlight off) 45 h (radio mode, backlight off) 68 h (connected probe, backlight always on) 33 h (radio mode, backlight always on)
Dimensions	182 x 64 x 40 mm
Weight	171 g

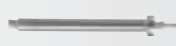
Suitable probes at a glance / Option: Radio

Immersion/penetr. probes	Illustration	Meas. range	Accuracy	t ₉₉	Part no.
Waterproof NTC immersion/penetration probe	 115 mm Ø 5 mm 50 mm Ø 4 mm	-50 to +150 °C ²⁾	±0.5% of mv (+100 to +150 °C) ±0.2 °C (-25 to +74.9 °C) ±0.4 °C (remaining range)	10 s	0613 1212 Conn.: Fixed cable, 1.2 m
Stainless steel NTC food probe (IP65) with PUR cable	 125 mm Ø 4 mm 15 mm Ø 3 mm	-50 to +150 °C ²⁾	±0.5% of mv (+100 to +150 °C) ±0.2 °C (-25 to +74.9 °C) ±0.4 °C (remaining range)	8 s	0613 2211 Conn.: Fixed cable, 1.6 m
Robust NTC food penetration probe with special handle, reinforced PUR cable	 115 mm Ø 5 mm 30 mm Ø 3.5 mm	-25 to +150 °C ²⁾	±0.5% of mv (+100 to +150 °C) ±0.2 °C (-25 to +74.9 °C) ±0.4 °C (remaining range)	7 s	0613 2411 Conn.: Fixed cable
Frozen food probe NTC, corkscrew design (incl. plug-in wire)	 110 mm Ø 8 mm 30 mm Ø 4 mm	-50 to +140 °C ¹⁾	±0.5% of mv (+100 to +140 °C) ±0.2 °C (-25 to +74.9 °C) ±0.4 °C (remaining range)	20 s	0613 3211 Conn.: Plug-in cable
Stainless steel NTC food probe (IP67) with PTFE cable to +250°C	 125 mm Ø 4 mm 15 mm Ø 3 mm	-50 to +150 °C ²⁾	±0.5% of mv (+100 to +150 °C) ±0.2 °C (-25 to +74.9 °C) ±0.4 °C (remaining range)	8 s	0613 3311 Conn.: Fixed cable
Air probes	Illustration	Meas. range	Accuracy	t ₉₉	Part no.
Efficient, robust NTC air probe	 115 mm Ø 5 mm 50 mm Ø 4 mm	-50 to +125 °C ²⁾	±0.2 °C (-25 to +80 °C) ±0.4 °C (remaining range)	60 s	0613 1712 Conn.: Fixed cable
Surface probes	Illustration	Meas. range	Accuracy	t ₉₉	Part no.
Waterproof NTC surface probe for flat surfaces	 115 mm Ø 5 mm 50 mm Ø 6 mm	-50 to +150 °C ²⁾	±0.5% of mv (+100 to +150 °C) ±0.2 °C (-25 to +74.9 °C) ±0.4 °C (remaining range)	35 s	0613 1912 Conn.: Fixed cable
Pipe wrap probe with Velcro for pipe diameter to max. 75 mm, T _{max.} +75°C, NTC	 300 mm	-50 to +70 °C	±0.2 °C (-25 to +70 °C) ±0.4 °C (-50 to -25.1 °C)		0613 4611 Conn.: Fixed cable

The measuring instrument inside TopSafe is waterproof with this probe.

1) Long-term meas. range +125 °C, short-term +140 °C
2) Long-term meas. range +125 °C, short-term +150 °C

Radio module for upgrading measuring instrument with radio option

Country versions	Radio freq.	Part no.
Radio module for measuring instrument, 869.85 MHz, approval for the countries: DE, FR, UK, BE, NL, ES, IT, SE, AT, DK, FI, HU, CZ, PL, GR, CH, PT, SI, MT, CY, SK, LU, EE, LT, IE, LV, NO	869.85 MHz FSK	0554 0188
Radio module for measuring instrument, 915.00 MHz FSK, approval for USA, CA, CL	915.00 MHz FSK	0554 0190

Radio probes for immersion/penetration measurements

Radio immersion/penetration probes	Meas. range	Accuracy	Resolution	t ₉₉
Radio immersion/penetration probe, NTC  105 mm 30 mm Ø 5 mm Ø 3.4 mm	-50 to +275 °C	±0.5 °C (-20 to +80 °C) ±0.8 °C (-50 to -20.1 °C) ±0.8 °C (+80.1 to +200 °C) ±1.5 °C (remaining range)	0.1 °C	t ₉₉ (in water) 12 s
Country versions	Radio freq.	Part no.		
Radio immersion/penetration probe, NTC, approval for the countries: DE, FR, UK, BE, NL, ES, IT, SE, AT, DK, FI, HU, CZ, PL, GR, CH, PT, SI, MT, CY, SK, LU, EE, LT, IE, LV, NO	869.85 MHz FSK	0613 1001		
Radio immersion/penetration probe, NTC, approval for USA, CA, CL	915.00 MHz FSK	0613 1002		

Radio probes: General technical data

Probe type	Radio immersion/penetration probe, NTC	Radio handle	Measuring rate	Radio transmission
Battery type	2 x 3V button cell (CR 2032)	2 AAA micro batteries	0.5 s or 10 s, adjustable on handle	Unidirectional
Battery life	150 h (meas. rate 0.5 s) 2 months (meas. rate 10 s)	215 h (meas. rate 0.5 s) 6 months (meas. rate 10 s)		Oper. temp. -20 to +50 °C
			Radio coverage Up to 20 m (without obstructions)	Storage temp. -40 to +70 °C
				Protection class IP54

Calibratable Temperature Measuring Instrument

testo 112

testo 112 combines two temperature measuring instruments in one. In addition to the complete NTC probe range, Pt100 probes can also be attached. In this way, the temperature range of -50 to +300 °C is covered to the highest accuracy level. testo 112 is therefore the ideal instrument for food measurements ranging from the deep-freeze sector to the oil temperature in deep-fat fryers.

The backlit display makes it easy to read in environments with poor lighting. Minimum and maximum values can be called up at the touch of a button. It is possible to print readings on site, for documentation purposes, on a fast printer (accessory).

- Large, backlit display with 14 mm high characters
- Call up max/min values at the touch of a button

Data printout on site on the Testo fast printer (optional)



TopSafe, indestructible protection case (optional)



Monitors temperature in refrigerated counter

testo 112

testo 112, 1 channel temperature measuring instrument NTC/Pt100, calibratable, with battery

Part no. 0560 1128

14.40

92.03

PTB Type approval

Printer and Accessories

Part no.

Testo fast printer with wireless infrared interface, 1 roll thermal paper and 4 AA batteries 0554 0549

Spare thermal paper for printer (6 rolls) 0554 0568

Spare thermal paper for printer (6 rolls) 0554 0569

External fast charger for 1-4 AA rech. batteries, incl. 4 Ni-MH rech. batteries with individual cell charging and charge control display, incl. impulse trickle charging, integrated discharge function, with built-in international mains plug, 100-240 V, 300 mA, 50/60 Hz 0554 0610

Additional accessories and spare parts

Part no.

9V rech. battery for instrument, instead of battery 0515 0025

Recharger for 9V rechargeable battery, for external recharging of 0515 0025 battery 0554 0025

Transport and Protection

Part no.

TopSafe, protects from impact and dirt 0516 0220

Transport case for meas. instr. and probes (405 x 170 x 85 mm) 0516 0201

Transport case for measuring instrument, 3 probes and accessories (430 x 310 x 85 mm) 0516 0200

Calibration Certificates

Part no.

ISO calibration certificate/temperature, for air/immersion probes, calibration points -18°C; 0°C; +60°C 0520 0001

ISO calibration certificate/temperature, meas. instr. with surface probe; calibration points +60°C; +120°C; +180°C 0520 0071

* TopSafe: TPU housing; TPE lid; PC stand

Technical data

Probe type	NTC	Pt100
Meas. range	-50 to +120 °C	-50 to +300 °C
Accuracy ±1 digit	±0.2 °C (-25 to +40 °C) ±0.3 °C (+40.1 to +80 °C) ±0.5 °C (remaining range)	±0.2 °C (-50 to +200 °C) ±0.3 °C (remaining range)
Resolution	0.1 °C	0.1 °C
Oper. temp.	-20 to +50 °C	
Storage temp.	-30 to +70 °C	
Battery type	9V block battery, 6F22	
Battery life	100 h	
Dimensions	182 x 64 x 40 mm	
Weight	171 g	

Suitable probes at a glance

Immers./penetr. probes (not calibratable)	Illustration	Meas. range	Accuracy	t99	Part no.
Waterproof NTC immersion/penetration probe	 115 mm Ø 5 mm 50 mm Ø 4 mm	-50 to +150 °C ²⁾	±0.5% of mv (+100 to +150 °C) ±0.2 °C (-25 to +74.9 °C) ±0.4 °C (remaining range)	10 s	0613 1212 Conn.: Fixed cable
Stainless steel NTC food probe (IP65) with PUR cable	 125 mm Ø 4 mm 15 mm Ø 3 mm	-50 to +150 °C ²⁾	±0.5% of mv (+100 to +150 °C) ±0.2 °C (-25 to +74.9 °C) ±0.4 °C (remaining range)	8 s	0613 2211 Conn.: Fixed cable
Robust NTC food penetration probe with special handle, reinforced PUR cable	 115 mm Ø 5 mm 30 mm Ø 3.5 mm	-25 to +150 °C ²⁾	±0.5% of mv (+100 to +150 °C) ±0.2 °C (-25 to +74.9 °C) ±0.4 °C (remaining range)	7 s	0613 2411 Conn.: Fixed cable
Frozen food probe NTC, corkscrew design (incl. plug-in wire)	 110 mm Ø 8 mm 30 mm Ø 4 mm	-50 to +140 °C ¹⁾	±0.5% of mv (+100 to +140 °C) ±0.2 °C (-25 to +74.9 °C) ±0.4 °C (remaining range)	20 s	0613 3211 Conn.: Plug-in cable
Stainless steel NTC food probe (IP67) with PTFE cable to +250°C	 125 mm Ø 4 mm 15 mm Ø 3 mm	-50 to +150 °C ²⁾	±0.5% of mv (+100 to +150 °C) ±0.2 °C (-25 to +74.9 °C) ±0.4 °C (remaining range)	8 s	0613 3311 Conn.: Fixed cable
Air probes	Illustration	Meas. range	Accuracy	t99	Part no.
Efficient, robust NTC air probe	 115 mm Ø 5 mm 50 mm Ø 4 mm	-50 to +125 °C ²⁾	±0.2 °C (-25 to +80 °C) ±0.4 °C (remaining range)	60 s	0613 1712 Conn.: Fixed cable
Surface probes	Illustration	Meas. range	Accuracy	t99	Part no.
Waterproof NTC surface probe for flat surfaces	 115 mm Ø 5 mm 50 mm Ø 6 mm	-50 to +150 °C ²⁾	±0.5% of mv (+100 to +150 °C) ±0.2 °C (-25 to +74.9 °C) ±0.4 °C (remaining range)	35 s	0613 1912 Conn.: Fixed cable
Pipe wrap probe with Velcro for pipe diameter to max. 75 mm, Tmax. +75°C, NTC	 300 mm	-50 to +70 °C	±0.2 °C (-25 to +70 °C) ±0.4 °C (-50 to -25.1 °C)		0613 4611 Conn.: Fixed cable

The measuring instrument inside TopSafe is waterproof with this probe.

1) Long-term meas. range +125 °C, short-term +140 °C
2) Long-term meas. range +125 °C, short-term +150 °C

testo 926 – Fast, accurate versatile thermometer

Experts are our favourite customers



Dettlef Higgelke,
Head of the
Testo Academy

...because they know what they are doing. We offer you our support with our field-oriented trainings on measurement procedures, stipulations and on physical interrelationships.

Even more important is the exchange with other specialists from your branch. After all, we are dealing with your competence and your professional routine when using our instruments.

By the way: 98% of our training participants fully recommend our seminars and training.



Wireless measurement using radio probes



Displays max./min. values in a two-line, backlit display



TopSafe. protects measuring instrument from impact, dirt and water, dishwasher-safe (optional)



On-site readings printout on Testo fast printer (optional)



testo 926

The fast-action, efficient temperature measuring instrument, testo 926, for the food sector. The optional TopSafe protection case renders it insensitive to dirt, therefore making it the ideal partner for large-scale kitchens, hotels, restaurants or the food industry. Besides measuring minimum and maximum values, readings can also be printed on site on the Testo fast printer. In addition to the wide range of standard probes with cable, a wireless radio probe can be used simultaneously, if required.

- Measurement parameters °C, °F, °R
- Fast-action probes for every application
- Wireless measurement with radio probes possible (optional)
- Audible alarm (adjustable alarm limits)
- Measurement data printout on site on the Testo fast printer
- TopSafe, the indestructible protection case (optional)



TopSafe, fast cleaning in the dishwasher



Air temperature measurement in refrigerated display counters and freezers



Auto-hold automatically recognises full-scale value



Measurement of penetration temperature when smoking foods, wireless radio transmission of measurement data

Printer and Accessories	Part no.
-------------------------	----------

Testo fast printer with wireless infrared interface, 1 roll thermal paper and 4 AA batteries, for printing out measurements on site	0554 0549
---	-----------

Spare thermal paper for printer (6 rolls), measurement data documentation legible for up to 10 years	0554 0568
--	-----------

Spare thermal paper for printer (6 rolls)	0554 0569
---	-----------

External fast charger for 1-4 AA rech. batteries, incl. 4 Ni-MH rech. batteries with individual cell charging and charge control display, incl. impulse trickle charging, integrated discharge function, with built-in international mains plug, 100-240 V, 300 mA, 50/60 Hz	0554 0610
--	-----------

Additional accessories	Part no.
------------------------	----------

9V rech. battery for instrument, instead of battery	0515 0025
---	-----------

Recharger for 9V rechargeable battery, for external recharging of 0515 0025 battery	0554 0025
---	-----------

Lithium battery, button cell, type CR 2032 for wireless probes	0515 0028
--	-----------

Transport and Protection	Part no.
--------------------------	----------

TopSafe, protects from impact and dirt	0516 0220
--	-----------

Case for measuring instrument and probes	0516 0210
--	-----------

Transport case for meas. instr. and probes (405 x 170 x 85 mm)	0516 0201
--	-----------

Transport case for measuring instrument, 3 probes and accessories (430 x 310 x 85 mm)	0516 0200
---	-----------

Calibration Certificates	Part no.
--------------------------	----------

ISO calibration certificate/temperature, for air/immersion probes, calibration points -18°C; 0°C; +60°C	0520 0001
---	-----------

ISO calibration certificate/temperature, meas. instr. with surface probe; calibration points +60°C; +120°C; +180°C	0520 0071
--	-----------

ISO calibration certificate/temperature, single point calibration for surface thermometer; calibration point +60°C	0520 0072
--	-----------

ISO calibration certificate/temperature, single point calibration for surface thermometer; calibration point +120°C	0520 0073
---	-----------

ISO calibration certificate/temperature, for air/immersion probes, calibration point -18°C	0520 0061
--	-----------

ISO calibration certificate/temperature, for air/immersion probes, calibration point 0°C	0520 0062
--	-----------

ISO calibration certificate/temperature, for air/immersion probes, calibration point +60°C	0520 0063
--	-----------

ISO calibration certificate/temperature, for air/immersion probes, calibration points -8°C; 0°C; +40°C	0520 0181
--	-----------

testo 926

testo 926-1, 1 channel food temperature measuring instrument T/C Type T, audible alarm, connection to an optional radio probe, with battery and calibration protocol

Part no. 0560 9261

testo 926, Starter set

testo 926, Starter set, 1 channel food temperature measuring instrument T/C Type T, incl. TopSafe, standard immersion/penetration probes, battery and calibration protocol

Part no. 0563 9262



Time for the essentials

"To be honest with you, the telephone is usually quiet between 6 and 7pm but the few people who do call are delighted. That's why I'm happy to be here too. Testo's Sales and Customer Service in Germany can be reached between 7am and 7pm."

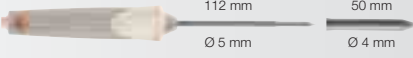
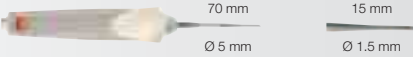
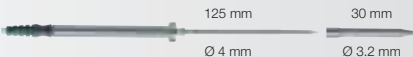
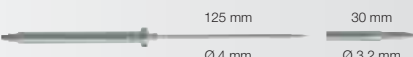
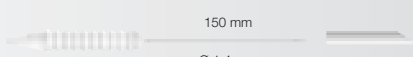
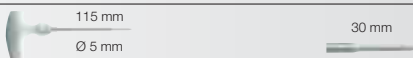
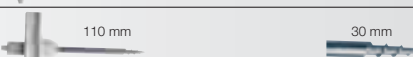
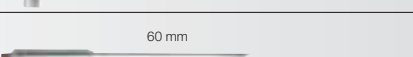
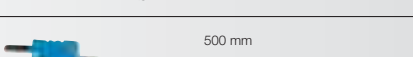
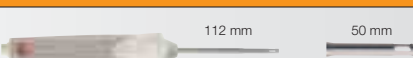
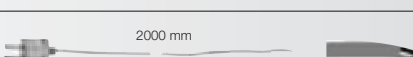
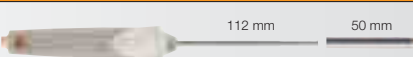

Regina Walz
Sales

Suitable probes at a glance / Technical data

Immersion/penetr. probes	Illustration	Meas. range	Accuracy	t99	Part no.
Waterproof standard immersion/penetration probe, T/C Type T	 112 mm Ø 5 mm / 50 mm Ø 4 mm	-50 to +350 °C	±0.2 °C (-20 to +70 °C) Class 1 (remaining range)	7 s	0603 1293 Conn.: Fixed cable
Waterproof precision immersion/penetration probe without visible penetration hole, T/C Type T	 70 mm Ø 5 mm / 15 mm Ø 1.5 mm	-50 to +350 °C	±0.2 °C (-20 to +70 °C) Class 1 (remaining range)		0603 2693 Conn.: Fixed cable
Stainless steel food probe (IP67) with PUR cable, T/C Type T	 125 mm Ø 4 mm / 30 mm Ø 3.2 mm	-50 to +350 °C	±0.2 °C (-20 to +70 °C) Class 1 (remaining range)	7 s	0603 2192 Conn.: Fixed cable
Stainless steel food probe (IP67), with PTFE cable to +250 °C, TC Type T	 125 mm Ø 4 mm / 30 mm Ø 3.2 mm	-50 to +350 °C	±0.2 °C (-20 to +70 °C) Class 1 (remaining range)	7 s	0603 3392 Conn.: Fixed cable
Waterproof, super-quick needle probe for measurements without visible penetration hole, T/C Type T	 150 mm Ø 1.4 mm	-50 to +250 °C	±0.2 °C (-20 to +70 °C) Class 1 (remaining range)	2 s	0628 0027 Conn.: Fixed cable
Robust food penetration probe with special handle, reinforced cable (PVC), T/C Type T	 115 mm Ø 5 mm / 30 mm Ø 3.5 mm	-50 to +350 °C	±0.2 °C (-20 to +70 °C) Class 1 (remaining range)	6 s	0603 2492 Conn.: Fixed cable
Frozen food probe, corkscrew design, T/C Type T	 110 mm Ø 8 mm / 30 mm Ø 4 mm	-50 to +350 °C	±0.2 °C (-20 to +70 °C) Class 1 (remaining range)	8 s	0603 3292 Conn.: Plug-in cable
Quick needle probe to monitor cooking in oven, T/C Type T	 60 mm Ø 1.4 mm	-50 to +250 °C	±0.2 °C (-20 to +70 °C) Class 1 (remaining range)	2 s	0628 0030 Conn.: Fixed cable
Measurement tip with T/C adapter Type T, ideal for fast-action measurement on incoming goods	 500 mm Ø 1.5 mm	-50 to +350 °C	Class 1	5 s	0628 0023
Air probes	Illustration	Meas. range	Accuracy	t99	Part no.
Robust, affordable air probe, T/C Type T	 112 mm Ø 5 mm / 50 mm Ø 4 mm	-50 to +350 °C	±0.2 °C (-20 to +70 °C) Class 1 (remaining range)	25 s	0603 1793 Conn.: Fixed cable
Flexible oven probe, Tmax +250 °C, PTFE cable	 2000 mm Ø 1.5 mm	-50 to +250 °C	Class 1	5 s	0603 0646
Surface probes	Illustration	Meas. range	Accuracy	t99	Part no.
Waterproof surface probe with widened measurement tip for flat surfaces, T/C Type T	 112 mm Ø 5 mm / 50 mm Ø 6 mm	-50 to +350 °C	±0.2 °C (-20 to +70 °C) Class 1 (remaining range)	30 s	0603 1993 Conn.: Fixed cable
 The measuring instrument inside TopSafe is waterproof with this probe.					

Technical data

Probe type Type T (Cu-CuNi) or NTC and Type K if radio immersion/penetration probes are used

Parameters °C, °F, °R

Meas. range -50 to +400 °C

Accuracy ±0.3 °C (-20 to +70 °C)
±1 digit ±(0.7 °C ±0.5% of mv) (remaining range)

Resolution 0.1 °C (-50 to +199.9 °C)
1 °C (remaining range)

Oper. temp. -20 to +50 °C

Storage temp. -40 to +70 °C

Battery type 9V block battery, 6F22

Battery life 200 h (connected probe, backlight off)
45 h (radio mode, backlight off)
68 h (connected probe, backlight always on)
33 h (radio mode, backlight always on)

Dimensions 182 x 64 x 40 mm

Weight 171 g

Option: Radio

Radio module for upgrading measuring instrument with radio option

Country versions	Radio freq.	Part no.
Radio module for measuring instrument, 869.85 MHz, approval for the countries: DE, FR, UK, BE, NL, ES, IT, SE, AT, DK, FI, HU, CZ, PL, GR, CH, PT, SI, MT, CY, SK, LU, EE, LT, IE, LV, NO	869.85 MHz FSK	0554 0188
Radio module for measuring instrument, 915.00 MHz FSK, approval for USA, CA, CL	915.00 MHz FSK	0554 0190

Radio probes for immersion/penetration measurements

Radio immersion/penetration probes	Meas. range	Accuracy	Resolution	t ₉₉
Radio immersion/penetration probe, NTC 	-50 to +275 °C	±0.5 °C (-20 to +80 °C) ±0.8 °C (-50 to -20.1 °C) ±0.8 °C (+80.1 to +200 °C) ±1.5 °C (remaining range)	0.1 °C	t ₉₉ (in water) 12 s
Country versions			Radio freq.	Part no.
Radio immersion/penetration probe, NTC, approval for the countries: DE, FR, UK, BE, NL, ES, IT, SE, AT, DK, FI, HU, CZ, PL, GR, CH, PT, SI, MT, CY, SK, LU, EE, LT, IE, LV, NO			869.85 MHz FSK	0613 1001
Radio immersion/penetration probe, NTC, approval for USA, CA, CL			915.00 MHz FSK	0613 1002

Assembled for you: Radio handles with probe head

Radio handles with probe head for air-/ immersion-penetration-meas.	Meas. range	Accuracy	Resolution	t ₉₉
Radio handle for attachable probe heads with T/C probe head for air and immersion/penetration measurement 	-50 to +350 °C Short-term to +500 °C	Radio handle: ±(0.5 °C +0.3% of mv) (-40 to +500 °C) ±(0.7 °C +0.5% of mv) (remaining range) T/C probe head: Class 2	0.1 °C (-50 to +199.9 °C) 1.0 °C (remaining range)	t ₉₉ (in water) 10 s
Country versions			Radio freq.	Part no.
Radio handle for plug-in probe heads, incl. T/C adapter, approval for the countries: DE, FR, UK, BE, NL, ES, IT, SE, AT, DK, FI, HU, CZ, PL, GR, CH, PT, SI, MT, CY, SK, LU, EE, LT, IE, LV, NO			869.85 MHz FSK	0554 0189
T/C probe head for air/immersion/penetration measurement, attachable to radio handle, T/C Type K				0602 0293
Radio handle for plug-in probe heads, incl. T/C adapter, approval for USA, CA, CL			915.00 MHz FSK	0554 0191
T/C probe head for air/immersion/penetration measurement, attachable to radio handle, T/C Type K				0602 0293
Radio handles with probe head for surface measurement				
Radio handle for attachable probe heads with T/C probe head for surface measurement 	-50 to +350 °C Short-term to +500 °C	Radio handle: ±(0.5 °C +0.3% of mv) (-40 to +500 °C) ±(0.7 °C +0.5% of mv) (remaining range) T/C probe head: Class 2	0.1 °C (-50 to +199.9 °C) 1.0 °C (remaining range)	5 s
Country versions			Radio freq.	Part no.
Radio handle for plug-in probe heads, incl. T/C adapter, approval for the countries: DE, FR, UK, BE, NL, ES, IT, SE, AT, DK, FI, HU, CZ, PL, GR, CH, PT, SI, MT, CY, SK, LU, EE, LT, IE, LV, NO			869.85 MHz FSK	0554 0189
T/C probe head for surface measurement, attachable to radio handle, T/C Type K				0602 0394
Radio handle for plug-in probe heads, incl. T/C adapter, approval for USA, CA, CL			915.00 MHz FSK	0554 0191
T/C probe head for surface measurement, attachable to radio handle, T/C Type K				0602 0394

Radio handles, separate

Radio handles for attachable T/C probes	Meas. range	Accuracy	Resolution
Radio handle for attachable probe heads incl. adapter for attaching T/C probes (Type K) 	-50 to +1000 °C	±(0.7 °C +0.3% of mv) (-40 to +900 °C) ±(0.9 °C +0.5% of mv) (remaining range)	0.1 °C (-50 to +199.9 °C) 1.0 °C (remaining range)
Country versions			Radio freq.
Radio handle for plug-in probe heads, incl. T/C adapter, approval for the countries: DE, FR, UK, BE, NL, ES, IT, SE, AT, DK, FI, HU, CZ, PL, GR, CH, PT, SI, MT, CY, SK, LU, EE, LT, IE, LV, NO			869.85 MHz FSK
Radio handle for plug-in probe heads, incl. T/C adapter, approval for USA, CA, CL			915.00 MHz FSK

Radio probes: General technical data

Probe type	Radio immersion/penetration probe, NTC	Radio handle	Measuring rate	Radio transmission
Battery type	2 x 3V button cell (CR 2032)	2 AAA micro batteries	0.5 s or 10 s, adjustable on handle	Unidirectional
Battery life	150 h (meas. rate 0.5 s) 2 months (meas. rate 10 s)	215 h (meas. rate 0.5 s) 6 months (meas. rate 10 s)		Oper. temp.
			Radio coverage	Storage temp.
			Up to 20 m (without obstructions)	-40 to +70 °C
				Protection class
				IP54

Spot check thermometer - Fast and efficient

testo 925

Fast-action spot check thermometer with special probes for hotels, industrial kitchens, catering industry, supermarkets etc.

- Stable surface probe for checking cooking plate, heating and baking tin temperatures e.g. in fast food restaurants.

- Robust immersion/penetration probe to monitor cooking processes or cooking oil temperature.

- Super-fast needle probe for temperature checks on thin goods such as hamburgers.

- Air probe for a fast temperature check e.g. in freezers.

An additional temperature probe can be displayed in the testo 925

measuring instrument; data transmission is by radio, i.e. wireless.

- Special probes for industrial kitchen sector
- 1 channel measuring instrument with optional radio probe
- Continuous display of max/min values
- Display light
- An audible alarm sounds when limit values are exceeded

testo 925

testo 925, 1 channel temperature measuring instrument T/C Type K, audible alarm, connection of an optional radio probe, with battery and calibration protocol

Part no. 0560 9250

Printer and Accessories Part no.

Testo fast printer with wireless infrared interface, 1 roll thermal paper and 4 AA batteries	0554 0549
Spare thermal paper for printer (6 rolls), measurement data documentation legible for up to 10 years	0554 0568
Spare thermal paper for printer (6 rolls)	0554 0569
Lithium battery, button cell, type CR 2032 for wireless probes	0515 0028

Transport and Protection Part no.

TopSafe, protects from impact and dirt	0516 0221
Case for measuring instrument and probes	0516 0210
Transport case for meas. instr. and probes (405 x 170 x 85 mm)	0516 0201
Transport case for measuring instrument, 3 probes and accessories (430 x 310 x 85 mm)	0516 0200

Calibration Certificates Part no.

ISO calibration certificate/temperature, for air/immersion probes, calibration points -18°C; 0°C; +60°C	0520 0001
ISO calibration certificate/temperature, meas. instr. with surface probe; calibration points +60°C; +120°C; +180°C	0520 0071



Measurement data printout on site on Testo fast printer (optional)



Practical checks on cooking plate temperature, for example



TopSafe, indestructible case, protects from dirt and impact (option)



Practical monitoring during cheese storage, wireless, measurement data transmission via radio

Technical data



Probe type	Type K (NiCr-Ni) or NTC if radio immersion/penetration probes are used
Meas. range	-50 to +1000 °C
Accuracy	±(0.5 °C +0.3% of mv) (-40 to +900 °C) ±1 digit
Resolution	0.1 °C (-50 to +199.9 °C) 1 °C (remaining range)
Oper. temp.	-20 to +50 °C
Storage temp.	-40 to +70 °C
Battery type	9V block battery, 6F22
Battery life	200 h (connected probe, backlight off) 45 h (radio mode, backlight off) 68 h (connected probe, backlight always on) 33 h (radio mode, backlight always on)
Dimensions	182 x 64 x 40 mm
Weight	171 g

Immers./penetr. probes	Illustration	Meas. range	Accuracy	t99	Part no.
Waterproof food probe made of stainless steel (IP65), TC Type K	125 mm 30 mm Ø 4 mm Ø 3.2 mm	-60 to +400 °C	Class 2	7 s	0602 2292 Conn.: Fixed cable
Robust food probe with special handle, IP 65, reinforced cable (PUR), T/C Type K	115 mm Ø 5 mm 30 mm Ø 3.5 mm	-60 to +400 °C	Class 1	6 s	0602 2492 Conn.: Fixed cable
Waterproof super-fast needle probe, highly accurate measurements without visible penetration hole. Specially for food, ideal for hamburgers, steaks, pizza, eggs etc., T/C Type K	150 mm Ø 1.4 mm 15 mm Ø 1 mm	-60 to +250 °C	Class 1	1 s	0628 0026 Conn.: Fixed cable
Waterproof robust immersion/penetration probe with metal protection hose Tmax +230°C, e.g. for monitoring temp. in cooking oil, T/C Type K	240 mm Ø 4 mm	-50 to +230 °C	Class 1	15 s	0628 1292 Conn.: Fixed cable

The measuring instrument inside TopSafe is waterproof with this probe.

* TopSafe: TPU casing; TPE lid; PC stand

Suitable probes at a glance / Option: Radio



Surface probes	Illustration	Meas. range	Accuracy	t ₉₉	Part no.
Stable, robust surface probe with PTFE standing area and metal protection hose T _{max} +230°C for cooking surfaces, heating and baking trays, T/C Type K	 120 mm Ø 60 mm	-50 to +230 °C	Class 2	45 s	0628 9992 Conn.: Fixed cable
Air probes	Illustration	Meas. range	Accuracy	t ₉₉	Part no.
Robust air probe, T/C Type K	 115 mm Ø 4 mm	-60 to +400 °C	Class 2	25 s	0602 1793 Conn.: Fixed cable

The measuring instrument inside TopSafe is waterproof with this probe.

Radio module for upgrading measuring instrument with radio option

Country versions	Radio freq.	Part no.
Radio module for measuring instrument, 869.85 MHz, approval for the countries: DE, FR, UK, BE, NL, ES, IT, SE, AT, DK, FI, HU, CZ, PL, GR, CH, PT, SI, MT, CY, SK, LU, EE, LT, IE, LV, NO	869.85 MHz FSK	0554 0188
Radio module for measuring instrument, 915.00 MHz FSK, approval for USA, CA, CL	915.00 MHz FSK	0554 0190

Assembled for you: Radio handles with probe head

Radio handles with probe head for air-/ immersion-penetration-meas.	Meas. range	Accuracy	Resolution	t ₉₉
Radio handle for attachable probe heads with T/C probe head for air and immersion/penetration measurement  100 mm 30 mm Ø 5 mm Ø 3,4 mm	-50 to +350 °C Short-term to +500 °C	Radio handle: ±(0.5 °C +0.3% of mv) (-40 to +500 °C) ±(0.7 °C +0.5% of mv) (remaining range) T/C probe head: Class 2	0.1 °C (-50 to +199.9 °C) 1.0 °C (remaining range)	t ₉₉ (in water) 10 s
Country versions	Radio freq.	Part no.		
Radio handle for plug-in probe heads, incl. T/C adapter, approval for the countries: DE, FR, UK, BE, NL, ES, IT, SE, AT, DK, FI, HU, CZ, PL, GR, CH, PT, SI, MT, CY, SK, LU, EE, LT, IE, LV, NO	869.85 MHz FSK	0554 0189		
T/C probe head for air/immersion/penetration measurement, attachable to radio handle, T/C Type K		0602 0293		
Radio handle for plug-in probe heads, incl. T/C adapter, approval for USA, CA, CL	915.00 MHz FSK	0554 0191		
T/C probe head for air/immersion/penetration measurement, attachable to radio handle, T/C Type K		0602 0293		
Radio handles with probe head for surface measurement	Meas. range	Accuracy	Resolution	t ₉₉
Radio handle for attachable probe heads with T/C probe head for surface measurement  120 mm 40 mm Ø 5 mm Ø 12 mm	-50 to +350 °C Short-term to +500 °C	Radio handle: ±(0.5 °C +0.3% of mv) (-40 to +500 °C) ±(0.7 °C +0.5% of mv) (remaining range) T/C probe head: Class 2	0.1 °C (-50 to +199.9 °C) 1.0 °C (remaining range)	5 s
Country versions	Radio freq.	Part no.		
Radio handle for plug-in probe heads, incl. T/C adapter, approval for the countries: DE, FR, UK, BE, NL, ES, IT, SE, AT, DK, FI, HU, CZ, PL, GR, CH, PT, SI, MT, CY, SK, LU, EE, LT, IE, LV, NO	869.85 MHz FSK	0554 0189		
T/C probe head for surface measurement, attachable to radio handle, T/C Type K		0602 0394		
Radio handle for plug-in probe heads, incl. T/C adapter, approval for USA, CA, CL	915.00 MHz FSK	0554 0191		
T/C probe head for surface measurement, attachable to radio handle, T/C Type K		0602 0394		

Radio handles, separate

Radio handles for attachable T/C probes	Meas. range	Accuracy	Resolution
Radio handle for attachable probe heads incl. adapter for attaching T/C probes (Type K) 	-50 to +1000 °C	±(0.7 °C +0.3% of mv) (-40 to +900 °C) ±(0.9 °C +0.5% of mv) (remaining range)	0.1 °C (-50 to +199.9 °C) 1.0 °C (remaining range)
Country versions	Radio freq.	Part no.	
Radio handle for plug-in probe heads, incl. T/C adapter, approval for the countries: DE, FR, UK, BE, NL, ES, IT, SE, AT, DK, FI, HU, CZ, PL, GR, CH, PT, SI, MT, CY, SK, LU, EE, LT, IE, LV, NO	869.85 MHz FSK	0554 0189	
Radio handle for plug-in probe heads, incl. T/C adapter, approval for USA, CA, CL	915.00 MHz FSK	0554 0191	

Radio probes: General technical data

Probe type	Radio immersion/penetration probe, NTC	Radio handle	Measuring rate	Radio transmission
Battery type	2 x 3V button cell (CR 2032)	2 AAA micro batteries	0.5 s or 10 s, adjustable on handle	Unidirectional
Battery life	150 h (meas. rate 0.5 s) 2 months (meas. rate 10 s)	215 h (meas. rate 0.5 s) 6 months (meas. rate 10 s)		Oper. temp. -20 to +50 °C
			Radio coverage Up to 20 m (without obstructions)	Storage temp. -40 to +70 °C
				Protection class IP54

Highly accurate alarm and logger thermometer – With site management

Monitoring food

Risk factor: Bacteria

Consumers may be exposed to health risks caused by bacteriological contamination of food. This risk becomes dangerous when a specified quantity of germs is exceeded. Bacterial growth relies on temperature!

Measurements on non-frozen food

For fast and accurate measurements, the penetration probe must be inserted at least 5 times, better 10 times as deep as it is thick.

Measurements on frozen food

Use probes suitable for large pieces (e.g. screw-in frozen food probe) and insert sufficiently (min. 4 cm). In the case of flat products (e.g. pizza, fish), use probes with a thin or reinforced measurement tip.

Measurements in freezers and cold storage rooms

The air temperature in freezers and cold storage rooms should be a constant $-18\text{ }^{\circ}\text{C}$. If monitoring over longer time periods, data loggers with alarm, if limit values are exceeded, are recommended. Fast-response probes for measuring penetration temperature are recommended when dispensing food. A minimum temperature of $+65\text{ }^{\circ}\text{C}$ to $+70\text{ }^{\circ}\text{C}$ is recommended.

Non-contact temperature measurement (screening test)

At greater distances, the ideal distance between measuring instrument and the object being measured is dependent on the optics of the infrared measuring instrument. Always measure the temperature of the packaging on packaged food; in the case of plastic seal packaging, only measure at points where the packaging comes into direct contact with the product. Major measurement errors occur if ice crystals or shiny, reflective surfaces are measured.



Wireless measurement using radio probes



Analyses and documents readings according to product names using PC software (included)



Displays site and parameter. Up to 99 product names can be stored in the instrument



On-site readings printout on Testo fast printer



testo 735-2

The robust and compact measuring instrument with a probe socket for highly accurate Pt100 probes and two sockets for fast-action thermocouple probes. Readings from up to three additional temperature probes can be displayed in the testo 735-2 measuring instrument's clear display; data transmission is by radio, i.e. wireless. The measurement values can be simultaneously transferred to a PC and stored there. In this way, a total of 6 channels is recorded by the measuring instrument. A system accuracy of 0.05 °C with a resolution of 0.001 °C is reached using the plug-in highly accurate Pt100 immersion/penetration probe. The measuring instrument is therefore ideally suited for use as a working standard.

Temperature characteristics are recorded in the instrument and then analysed in graphics and tables on your PC/Notebook. Data is printed on site on the Testo fast printer using infrared.

Selectable user profiles, i.e. allocation of specific function buttons to an application facilitate intuitive and fast operation. Individual protocols or measurement series can be stored according to site. Up to 99 sites can be stored in the instrument. The storage cycle is user-defined between 0.5 seconds and 24 hours.

- System accuracy up to 0.05 °C
- Instrument memory for up to 10,000 readings
- PC software for filing, analysing and documenting measurement data (included)
- Displays, saves and prints Delta T, min, max and mean values
- Audible alarm if limit values are exceeded
- Protection class IP65

PC software for filing and documenting measurement data (included)



Spot checks for frozen goods in refrigerated rooms



Fast documentation thanks to on-site data printout



Checks temperature when dispensing food; no annoying cables thanks to radio probes



testo 735-2

testo 735-2, 3 channel temperature measuring instrument T/C Type T/J/K/S/Pt100, audible alarm, connection for max. 3 optional radio probes, with data memory, PC software and USB data transmission cable, with battery and calibration protocol

Part no. 0563 7352

Printer and Accessories	Part no.
Testo fast printer with wireless infrared interface, 1 roll thermal paper and 4 AA batteries	0554 0549
Spare thermal paper for printer (6 rolls), measurement data documentation legible for up to 10 years	0554 0568
Spare thermal paper for printer (6 rolls)	0554 0569
External fast charger for 1-4 AA rech. batteries, incl. 4 Ni-MH rech. batteries with individual cell charging and charge control display, incl. impulse trickle charging, integrated discharge function, with built-in international mains plug, 100-240 V, 300 mA, 50/60 Hz	0554 0610
Additional accessories	Part no.
Plug-in mains adapter, 5 VDC 500 mA with European adapter, 100-250 VAC, 50-60 Hz	0554 0447
Lithium battery, button cell, type CR 2032 for wireless probes	0515 0028

Transport and Protection	Part no.
Service case for basic equipment of measuring instrument and probes, dimensions: 400 x 310 x 96 mm	0516 0035
Service case for measuring instrument, probes and accessories, dimensions 520 x 380 x 120 mm	0516 0735
Calibration Certificates	Part no.
ISO calibration certificate/temperature, single point calibration for surface thermometer; calibration point +60°C	0520 0072
ISO calibration certificate/temperature, single point calibration for surface thermometer; calibration point +120°C	0520 0073
ISO calibration certificate/temperature, for air/immersion probes, calibration points -18°C; 0°C; +60°C	0520 0001
ISO calibration certificate/temperature, for air/immersion probes, calibration points -8°C; 0°C; +40°C	0520 0181

Suitable probes at a glance / Technical data

Immersion/penetr. probes	Illustration	Meas. range	Accuracy	t99	Part no.
Waterproof standard immersion/penetration probe, T/C Type T	112 mm 50 mm Ø 5 mm Ø 4 mm	-50 to +350 °C	±0.2 °C (-20 to +70 °C) Class 1 (remaining range)	7 s	0603 1293 Conn.: Fixed cable
Waterproof precision immersion/penetration probe without visible penetration hole, T/C Type T	70 mm 15 mm Ø 5 mm Ø 1.5 mm	-50 to +350 °C	±0.2 °C (-20 to +70 °C) Class 1 (remaining range)		0603 2693 Conn.: Fixed cable
Stainless steel food probe (IP67) with PUR cable, T/C Type T	125 mm 30 mm Ø 4 mm Ø 3.2 mm	-50 to +350 °C	±0.2 °C (-20 to +70 °C) Class 1 (remaining range)	7 s	0603 2192 Conn.: Fixed cable
Stainless steel food probe (IP67), with PTFE cable to +250 °C, TC Type T	125 mm 30 mm Ø 4 mm Ø 3.2 mm	-50 to +350 °C	±0.2 °C (-20 to +70 °C) Class 1 (remaining range)	7 s	0603 3392 Conn.: Fixed cable
Waterproof, super-quick needle probe for measurements without visible penetration hole, T/C Type T	150 mm Ø 1.4 mm	-50 to +250 °C	±0.2 °C (-20 to +70 °C) Class 1 (remaining range)	2 s	0628 0027 Conn.: Fixed cable
Robust food penetration probe with special handle, reinforced cable (PVC), T/C Type T	115 mm 30 mm Ø 5 mm Ø 3.5 mm	-50 to +350 °C	±0.2 °C (-20 to +70 °C) Class 1 (remaining range)	6 s	0603 2492 Conn.: Fixed cable
Frozen food probe, corkscrew design, T/C Type T	110 mm 30 mm Ø 8 mm Ø 4 mm	-50 to +350 °C	±0.2 °C (-20 to +70 °C) Class 1 (remaining range)	8 s	0603 3292 Conn.: Plug-in cable
Quick needle probe to monitor cooking in oven, T/C Type T	60 mm Ø 1.4 mm	-50 to +250 °C	±0.2 °C (-20 to +70 °C) Class 1 (remaining range)	2 s	0628 0030 Conn.: Fixed cable
Measurement tip with T/C adapter Type T, ideal for fast-action measurement on incoming goods	500 mm Ø 1.5 mm	-50 to +350 °C	Class 1	5 s	0628 0023
Laboratory probe Pt100, glass-coated, exchangeable glass pipe (Duran 50), resistant to corrosive substances	200 mm 30 mm Ø 6 mm Ø 5 mm	-50 to +400 °C	Class A (-50 to +300 °C), Class B (remaining range)	45 s	0609 7072 Conn.: Fixed cable
Highly accurate Pt100 immersion/penetration probe incl. factory certificate (test points 0 °C and +156 °C)	295 mm Ø 4 mm	-40 to +300 °C	±0.05 °C (+0.01 to +100 °C) ±(0.05 °C + 0.05% of mv) (remaining range)	60 s	0614 0235 Conn.: Fixed cable
Air probes	Illustration	Meas. range	Accuracy	t99	Part no.
Robust, affordable air probe, T/C Type T	112 mm 50 mm Ø 5 mm Ø 4 mm	-50 to +350 °C	±0.2 °C (-20 to +70 °C) Class 1 (remaining range)	25 s	0603 1793 Conn.: Fixed cable
Surface probes	Illustration	Meas. range	Accuracy	t99	Part no.
Waterproof surface probe with widened measurement tip for flat surfaces, T/C Type T	112 mm 50 mm Ø 5 mm Ø 6 mm	-50 to +350 °C	±0.2 °C (-20 to +70 °C) Class 1 (remaining range)	30 s	0603 1993 Conn.: Fixed cable

The measuring instrument inside TopSafe is waterproof with this probe.

Technical data				
Probe type*	Pt100	Pt100 with probe 0614 0235	Type K (NiCr-Ni)	Type T (Cu-CuNi)
Meas. range	-200 to +800 °C	-40 to +300 °C	-200 to +1370 °C	-200 to +400 °C
Accuracy ±1 digit	±0.2 °C (-100 to +199.9 °C) ±0.2% of mv (remaining range)	See probe data	±0.3 °C (-60 to +60 °C) ±(0.2 °C + 0.3% of mv) (remaining range)	±0.3 °C (-60 to +60 °C) ±(0.2 °C + 0.3% of mv) (remaining range)
Resolution	0.05 °C	0.001 °C (-40 to +199.999 °C) 0.01 °C (remaining range)	0.1 °C	0.1 °C
Probe type*	Type J (Fe-CuNi)	Type S (Pt10Rh-Pt)		
Meas. range	-200 to +1000 °C	0 to +1760 °C		
Accuracy ±1 digit	±0.3 °C (-60 to +60 °C) ±(0.2 °C + 0.3% of mv) (remaining range)	±1 °C		
Resolution	0.1 °C	1 °C		
Battery type	Alkali manganese, mignon, Type AA		Oper. temp.	-20 to +50 °C
Battery life	Approx. 300 h with TC probe Approx. 250 h with Pt100 Approx. 60 h with 0614 0235		Storage temp.	-30 to +70 °C
			Dimensions	220 x 74 x 46 mm
Protection class IP65			Weight	428 g

*Probe type NTC when using radio immersion/penetration probes

Option: Radio



Radio module for upgrading measuring instrument with radio option

Country versions	Radio freq.	Part no.
Radio module for measuring instrument, 869.85 MHz, approval for the countries: DE, FR, UK, BE, NL, ES, IT, SE, AT, DK, FI, HU, CZ, PL, GR, CH, PT, SI, MT, CY, SK, LU, EE, LT, IE, LV, NO	869.85 MHz FSK	0554 0188
Radio module for measuring instrument, 915.00 MHz FSK, approval for USA, CA, CL	915.00 MHz FSK	0554 0190

Radio probes for immersion/penetration measurements

Radio immersion/penetration probes	Meas. range	Accuracy	Resolution	t ₉₉
Radio immersion/penetration probe, NTC 	-50 to +275 °C	±0.5 °C (-20 to +80 °C) ±0.8 °C (-50 to -20.1 °C) ±0.8 °C (+80.1 to +200 °C) ±1.5 °C (remaining range)	0.1 °C	t ₉₉ (in water) 12 s
Country versions	Radio freq.	Part no.		
Radio immersion/penetration probe, NTC, approval for the countries: DE, FR, UK, BE, NL, ES, IT, SE, AT, DK, FI, HU, CZ, PL, GR, CH, PT, SI, MT, CY, SK, LU, EE, LT, IE, LV, NO	869.85 MHz FSK	0613 1001		
Radio immersion/penetration probe, NTC, approval for USA, CA, CL	915.00 MHz FSK	0613 1002		

Assembled for you: Radio handles with probe head

Radio handles with probe head for air-/ immersion-penetration-meas.	Meas. range	Accuracy	Resolution	t ₉₉
Radio handle for attachable probe heads with T/C probe head for air and immersion/penetration measurement 	-50 to +350 °C Short-term to +500 °C	Radio handle: ±(0.5 °C +0.3% of mv) (-40 to +500 °C) ±(0.7 °C +0.5% of mv) (remaining range) T/C probe head: Class 2	0.1 °C (-50 to +199.9 °C) 1.0 °C (remaining range)	t ₉₉ (in water) 10 s
Country versions	Radio freq.	Part no.		
Radio handle for plug-in probe heads, incl. T/C adapter, approval for the countries: DE, FR, UK, BE, NL, ES, IT, SE, AT, DK, FI, HU, CZ, PL, GR, CH, PT, SI, MT, CY, SK, LU, EE, LT, IE, LV, NO	869.85 MHz FSK	0554 0189		
T/C probe head for air/immersion/penetration measurement, attachable to radio handle, T/C Type K			0602 0293	
Radio handle for plug-in probe heads, incl. T/C adapter, approval for USA, CA, CL	915.00 MHz FSK	0554 0191		
T/C probe head for air/immersion/penetration measurement, attachable to radio handle, T/C Type K			0602 0293	
Radio handles with probe head for surface measurement	Meas. range	Accuracy	Resolution	t ₉₉
Radio handle for attachable probe heads with T/C probe head for surface measurement 	-50 to +350 °C Short-term to +500 °C	Radio handle: ±(0.5 °C +0.3% of mv) (-40 to +500 °C) ±(0.7 °C +0.5% of mv) (remaining range) T/C probe head: Class 2	0.1 °C (-50 to +199.9 °C) 1.0 °C (remaining range)	5 s
Country versions	Radio freq.	Part no.		
Radio handle for plug-in probe heads, incl. T/C adapter, approval for the countries: DE, FR, UK, BE, NL, ES, IT, SE, AT, DK, FI, HU, CZ, PL, GR, CH, PT, SI, MT, CY, SK, LU, EE, LT, IE, LV, NO	869.85 MHz FSK	0554 0189		
T/C probe head for surface measurement, attachable to radio handle, T/C Type K			0602 0394	
Radio handle for plug-in probe heads, incl. T/C adapter, approval for USA, CA, CL	915.00 MHz FSK	0554 0191		
T/C probe head for surface measurement, attachable to radio handle, T/C Type K			0602 0394	

Radio handles, separate

Radio handles for attachable T/C probes	Meas. range	Accuracy	Resolution
Radio handle for attachable probe heads incl. adapter for attaching T/C probes (Type K) 	-50 to +1000 °C	±(0.7 °C +0.3% of mv) (-40 to +900 °C) ±(0.9 °C +0.5% of mv) (remaining range)	0.1 °C (-50 to +199.9 °C) 1.0 °C (remaining range)
Country versions	Radio freq.	Part no.	
Radio handle for plug-in probe heads, incl. T/C adapter, approval for the countries: DE, FR, UK, BE, NL, ES, IT, SE, AT, DK, FI, HU, CZ, PL, GR, CH, PT, SI, MT, CY, SK, LU, EE, LT, IE, LV, NO	869.85 MHz FSK	0554 0189	
Radio handle for plug-in probe heads, incl. T/C adapter, approval for USA, CA, CL	915.00 MHz FSK	0554 0191	

Radio probes: General technical data

Probe type	Radio immersion/penetration probe, NTC	Radio handle	Measuring rate	Radio transmission
Battery type	2 x 3V button cell (CR 2032)	2 AAA micro batteries	0.5 s or 10 s, adjustable on handle	Unidirectional
Battery life	150 h (meas. rate 0.5 s) 2 months (meas. rate 10 s)	215 h (meas. rate 0.5 s) 6 months (meas. rate 10 s)		Oper. temp. -20 to +50 °C
			Radio coverage Up to 20 m (without obstructions)	Storage temp. -40 to +70 °C
				Protection class IP54

Reference measuring instrument – With highest precision

testo 950

Assuring quality means adhering to temperatures. The testo 950 precision measuring instrument can be used for frozen food temperatures to high oven temperatures. The measuring instrument combines user-friendly menu-driven operation and has a system accuracy of up to 0.05°C.

A readings memory for max. 500,000 readings is available for long-term measurement. All important parameters such as start and end of measurement, measurement intervals, limits exceeded/fallen short of and date/time can be programmed.

The saved measurement data can be analysed using PC software or printed on the Testo fast printer on site.

- System accuracy up to 0.05 °C and up to a resolution of 0.001 °C with precision probe 0614 0240

- System adjustment integrated in measuring instrument – fast thermocouple probes can be adjusted to a reference value using the 0614 0240 precision probe.

testo 950

Reference temperature measuring instrument, incl. battery, Li cell and calibration protocol

Part no. 0563 9501



Monitoring the cooking temperature

Accessories for measuring instrument/Probes	Part no.	Printer and Accessories	Part no.
Rech. batt. set for instr. (2 rech. 2.4V/1100mAh), selected for quick recharging in instrument	0554 0196	Attachable printer (securely attached) including 1 roll of thermal paper and batteries	0554 0570
Mains unit 230 V/ 8 V/ 1 A, for instrument (European plug), for mains operation and battery recharging	0554 1084	Testo fast printer with wireless infrared interface, 1 roll thermal paper and 4 AA batteries	0554 0549
Car charging adapter, ready to measure following recharging in car, battery is recharged while travelling in car	0554 0424		
Software and Accessories	Part no.	SoftCase for instrument and printer	Part no.
ComSoft 3 - Professional with data management, incl. database, analysis and graphics function, data analysis, trend curve	0554 0830	SoftCase (protects instrument from impact) with carrier strap, magnetic holder and probe holder	0516 0401
RS232 cable, connects instrument to PC (1.8 m) for data transfer	0409 0178	SoftCase for attachable printer (protects printer from dirt/impact)	0516 0411
Ethernet adapter, RS232 - Ethernet incl. software driver, mains unit, facilitates data communication in network	0554 1711	System case	Part no.
		System case (plastic) for measuring instrument, probes and accessories, probes in lid make it easy to find parts in case (540 x 440 x 130 mm)	0516 0400

Description	Illustration	Meas. range	Accuracy	t99	Part no.
Highly accurate immersion/penetration probe incl. certificate	295 mm Ø 4 mm Stainless Steel	-40 to +300 °C	±0.05 °C (+0.01 to +100 °C) ±(0.05 °C ±0.05% of mv) (-40 to 0 °C) ±(0.05 °C ±0.05% of mv) (+100.01 to +300 °C)	60 s	0614 0240 Conn.: Plug-in head, connection cable 0430 0143 or 0430 0145 required
Super quick-action immersion/penetration probe for measurements in gases and liquids with a low-mass tip	150 mm Ø 1.4 mm 20 mm Ø 0.5 mm	-200 to +600 °C Class 1		1 s	0604 9794 Conn.: Plug-in head, connection cable 0430 0143 or 0430 0145 required
Robust immersion/penetration probe with sharpened measuring tip, waterproof and oven-proof	150 mm Ø 3.5 mm Ø 3 mm	-200 to +400 °C Class A		30 s	0604 2573 Conn.: Fixed cable
Robust food probe with special handle, IP 65, reinforced cable (PUR), T/C Type K	115 mm Ø 5 mm 30 mm Ø 3.5 mm	-60 to +400 °C Class 1	Please also order the 0600 1693 T/C adapter	6 s	0602 2492 Conn.: Fixed cable
Super quick-action surface probe, probe tip at 90° angle, with sprung thermocouple strip	100 mm 50 mm Ø 10 mm	-200 to +300 °C Class 2		3 s	0604 0994 Conn.: Plug-in head, connection cable 0430 0143 or 0430 0145 required
Stable, robust surface probe with PTFE standing area and metal protection hose Tmax +230°C for cooking surfaces, heating and baking trays, T/C Type K	120 mm Ø 60 mm	-50 to +230 °C Class 2	Please also order the 0600 1693 T/C adapter	45 s	0628 9992 Conn.: Fixed cable
Precision air probe	150 mm Ø 3 mm Ø 9 mm	-100 to +400 °C	1/10 Class B (0 to 100°C) 1/5 Class B (rem. range) to EN 60751	75 s	0628 0017 Conn.: Plug-in head, connection cable 0430 0143 or 0430 0145 required

For further information and calibration certificates, please refer to our brochure "Portable Reference Measurement Engineering" and www.testo.com.

Monitor ambient storage conditions – Efficiently and Accurately

testo 608-H1 /-H2

The affordable standard testo 608-H1 hygrometer measures humidity, temperature and dewpoint non-stop.

The efficient testo 608-H2 alarm hygrometer with LED alarm function for accurate signals when limits are exceeded.

- With dewpoint calculation and Max/Min value display
- Humidity sensor unaffected by condensation



Display easily legible at a distance



testo 608-H2 with LED alarm



Reliable monitoring of storage conditions in the food sector

testo 608-H1

Humidity/Dewpoint/Temperature measuring instrument incl. battery

Part no. 0560 6081

testo 608-H2 with alarm

Humidity/dewpoint/temperature measuring instrument, incl. LED alarm, battery and calibration protocol

Part no. 0560 6082

Technical data	testo 608-H1	testo 608-H2
Meas. range	+10 to +95 %RH 0 to +50 °C -20 to +50 °C td	+2 to +98 %RH -10 to +70 °C -40 to +70 °C td
Accuracy ±1 digit	±3 %RH (+10 to +95 %RH) ±0.5 °C (at +25 °C)	±2 %RH (+2 to +98 %RH) ±0.5 °C (at +25 °C)
Oper. temp.	0 to +50 °C	-10 to +70 °C
Resolution	0.1 %RH / 0.1 °C	Measuring rate 18 s
Storage temp.	-40 to +70 °C	Dimensions 120 x 89 x 40 mm
Battery life	8736 h	Weight 168 g

Accessories Ordering data

Part no.

ISO calibration certificate humidity, Calibration points 11.3 %RH and 75.3 %RH at +25°C 0520 0006

Mini infrared thermometer – Pocket-size

testo 805

The infrared thermometer, which is only 80 mm in size, fits inside any pocket and is always ready at hand for fast measurements in Incoming Goods, for example. Also ideal for quick measurements when distributing food.

- High accuracy in a critical area for food
- Packaging remains undamaged
- TopSafe is dishwasher-proof
- Display of minimum and maximum values
- Scan mode for permanent measurement



Robust, waterproof protection case (IP65), optional



Fast temperature measurement as you pass by

testo 805

Mini infrared thermometer and battery

Part no. 0560 8051

Set for fast inspections

Mini infrared thermometer, TopSafe and battery

Part no. 0563 8051

Accessories Ordering data

Part no.

TopSafe, robust, waterproof protection case (IP65)

0516 8051

ISO calibration certificate/Temperature, Infrared thermometers, calibration points 0°C, +60°C

0520 0452

Technical data

Meas. range	-25 to +250 °C		
Accuracy	±3 °C (-25 to -21 °C) ±2 °C (-20 to -2.1 °C) ±1 °C (-2 to +40 °C)		±1.5 °C (+40.1 to +150 °C) ±2% of mv (+150.1 to +250 °C)
Resolution	0.1 °C (-9.9 to +199.9 °C)		1 °C (remaining range)
Distance to measurement spot	1:1		
Emissivity	0.95 (adjustable to 0.95 or 1.00)		
Reaction time	< 1.0 s	Dimensions	80 x 31 x 19 mm
Oper. temp.	0 to +50 °C	Weight	28 g
Storage temp.	-20 to +65 °C		

Temperature measurement – Non-contact

testo 826-T1

Non-contact and fast temperature monitoring of food, convenient and without damaging the packaging.

- High accuracy
- Wall/belt holder included
- Visual alarm testo 826-T1
- Audible alarm testo 826-T2

testo 826-T2

The thermometer has an additional laser sighting.

- 6:1 opening ratio (distance/spot diameter)
- Fast measurement without destroying packaging

Water-proof and robust on account of TopSafe (IP67) (included)



testo 826-T2 with laser sighting and audible alarm

Temperature screening test on food e.g. in freezers, refrigerated storerooms etc.

testo 826-T1

Infrared thermometer without sighting, with TopSafe and wall/belt holder

Part no. 0563 8261

testo 826-T2 with laser

Infrared thermometer with laser sighting and audible alarm, incl. TopSafe and wall/belt holder

Part no. 0563 8262

Accessories Ordering data

ISO calibration certificate/temperature, Infrared thermometers, calibration points -18°C, 0°C, +60°C
Part no. 0520 0401

Technical data

Meas. range	-50 to +300 °C	
Accuracy	±1.5 °C (-20 to +100 °C) ±1 digit	
Resolution	0.5 °C	Storage temp. -40 to +70 °C
Oper. temp.	0 to +50 °C (826-T1)	-20 to +50 °C (826-T2)
Battery life	Approx. 150 h	Approx. 20 h (cont. oper.) (826-T2)

Temperature measurement – Non-contact or direct

testo 826-T3/-T4

Fast, non-contact measurement and core temperature measurement in one instrument. The surface temperature is measured with the infrared side while the penetration side can be used to measure the core temperature.

826-T4 also has a laser sighting and a reliable audible alarm.

- High accuracy
- Wall/belt holder included
- TopSafe case protects from impact, dirt and water
- Optical alarm testo 826-T3
- Audible alarm testo 826-T4
- 6:1 opening ratio (distance/spot diameter)



Only in combination with TopSafe



testo 826-T4 with laser sighting and audible alarm



Thin, robust measurement tip



Temperature screening test and core temperature measurement

testo 826-T3

Infrared and contact thermometer with TopSafe, wall/belt holder, probe protection cap and drill for frozen food

Part no. 0563 8263

Accessories Ordering data

ISO calibration certificate/temperature, for air/immersion probes, calibration point -18°C
Part no. 0520 0061

ISO calibration certificate/temperature, for air/immersion probes, calibration point 0°C
Part no. 0520 0062

ISO calibration certificate/temperature, for air/immersion probes, calibration points -18°C, 0°C, +60°C
Part no. 0520 0001

ISO calibration certificate/temperature, Infrared thermometers, calibration points -18°C, 0°C, +60°C
Part no. 0520 0401

ISO calibration certificate/temperature, Infrared thermometers, calibration points 0°C, +60°C
Part no. 0520 0452

testo 826-T4 with laser

Infrared and contact thermometer with laser and alarm, TopSafe, wall/belt holder, protection cap, frozen food drill

Part no. 0563 8264

Technical data	Infrared thermometer	Contact thermometer
Meas. range	-50 to +300 °C	-50 to +230 °C
Accuracy ±1 digit	±1.5 °C (-20 to +100 °C) ±2 °C or 2% of mv (remaining range)	±0.5 °C (-20 to +99.9 °C) ±1 °C or 1% of mv (remaining range)
Resolution	0.5 °C	0.1 °C
Oper. temp.	0 to +50 °C (826-T3)	-20 to +50 °C (826-T4)

Distance thermometer for infrared monitoring measurements

testo 831

Thanks to its 30:1 optics, the measurement spot diameter is only 3.6 cm at a distance of 1 m. This means that even small objects such as yoghurt pots can be easily measured at a distance. Measurement errors are avoided due to a 2-point laser which indicates the exact measurement spot. At two measurements per second, the testo 831 is so fast that measurements on palettes or refrigerated shelves can be carried out in seconds.

- Infrared thermometer with 30:1 optics
- Broad measurement range of -30 to +210 °C
- Backlit display
- Alarm limit values can be set and are optically and audibly indicated
- Including belt holder and factory calibration certificate
- Also available as a set with the core thermometer testo 106



2-point laser marking (actual measurement spot)



Backlit display



Fast and easy checks on refrigerated displays

Set

In certain applications, it is necessary to carry out an additional core temperature measurement, or an additional core thermometer is required for measuring the temperature of food before serving. For this purpose, Testo offers an economical set consisting of testo 831 and the proven testo 106 core thermometer.



Set consisting of : testo 831 and the core thermometer testo 106

testo 831

testo 831, infrared thermometer including belt holder, battery, instruction manual and factory calibration certificate with the measurement points -20 and +80 °C

Part no. 0560 8310

Set with testo 831 and testo 106

Set testo 831 and testo 106 - Infrared thermometer including belt holder, battery, instruction manual and factory calibration certificate with the measurement points -20 and +80 °C, and penetration thermometer testo 106 including TopSafe, belt holder, battery and instruction manual

Part no. 0563 8310

testo 831: 2-point laser for marking measurement spot

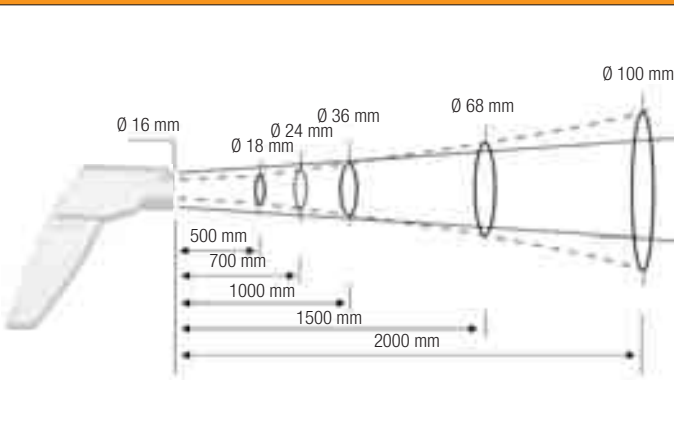

Accessories Ordering data

Accessories Ordering data	Part no.
9V rech. battery for instrument, instead of battery	0515 0025
Recharger for 9V rechargeable battery, for external recharging of 0515 0025 battery	0554 0025
ISO calibration certificate/temperature, Infrared thermometers, calibration points -18°C, 0°C, +60°C	0520 0401
ISO calibration certificate/Temperature, Infrared thermometers, calibration points 0°C, +60°C	0520 0452

Technical data

Meas. range	-30 to +210 °C
Spectral range	8 to 14 μm
Accuracy	±1,5 °C or ±1,5% of mv (-20 to +210 °C) ±1 digit ± 2 °C or ±2% of mv (remaining range)
Resolution	0,5 °C
Meas. spot marking	2-point laser
Distance to measurement spot	30:1
Emissivity	Adjustable 0.2 to 1.0
Oper. temp.	-20 to +50 °C
Storage temp.	-40 to +70 °C
Display	Illuminated LCD
Protection class	IP30
Dimensions	190 x 75 x 38 mm
Weight	200 g

Technical data testo 106 see page 9

testo 845 – the infrared measurement technology for temperature with integrated humidity module

The testo 845 is a milestone in non-contact temperature measurement. For the first time, surface temperatures with smallest diameters can be measured accurately at short and long distances. The switchable optics for far-field and close focus measurement make this possible.

testo 845 is equipped with an optical resolution of 75:1 for far-field measurements. Surface temperatures can be measured accurately even at great distances from the object to be measured. At a distance of 1.2 metres from the object to be measured, the measuring spot diameter is only 16 mm. A cross laser marks the measuring spot exactly during measurement. Incorrect measurements are eliminated - you always know exactly where you are measuring.

The close focus optics allow the measurement of temperatures on the smallest surfaces with a diameter of just 1 mm and a distance of 70 mm! Two lasers mark the measuring spot exactly.

- Switchable optics for far-field measurements (75:1) and close focus (1 mm, 70 mm distance)
- Especially bright cross laser sighting for indicating the actual measuring point
- Reference accuracy ± 0.75 °C with super-fast measurement technology (scanning 100 ms)
- Backlit display (3-line), shows °C, min./max. values, alarm limit values and emissivity; in addition display with humidity module: %RH, °Ctd
- Optical and audible alarm when limit values are exceeded
- Instrument memory for 90 measurement protocols
- PC software for archiving and documenting measurement data (included in delivery)
- Tripod fitting for online measurement via USB cable (included in delivery)



Switch optics 1:
Far-field 75:1 (16 mm,
distance 1200 mm) with
cross laser marking



Switch optics 2:
close focus (1 mm,
distance 70 mm) with 2-
point laser marking



testo 845 with additional
humidity module for
measuring ambient air
humidity and for
determining dewpoint
distance



Fast documentation with
measurement data
printout on site



Infrared Thermometer with Switchable Optics (far-field/close focus)

testo 845



testo 845, infrared temperature measuring instrument with cross-laser sighting, switchable optics for far-field and close focus measurement, contact temperature probe attachable, optical/audible alarm, reading memory, PC software incl. USB data transfer cable, aluminium case, battery and calibration protocol

Part no. 0563 8450

testo 845 with integrated humidity module

testo 845, infrared temperature measuring instrument with cross laser sighting incl. humidity module, switchable optics for far-field and close focus measurement, contact temperature probe attachable, optical/audible alarm, reading memory, PC software incl. USB data transfer cable, aluminium case, battery and calibration protocol

Part no. 0563 8451

Description	Meas. range	Part no.
Fast-action surface probe with sprung thermocouple strip, also for uneven surfaces, measurement range short-term to +500°C, TC Type K	-60 to +300 °C	0602 0393
		
Robust air probe, T/C Type K	-60 to +400 °C	0602 1793
		

Accessories Ordering data	Part no.
Humidity module, upgradeable for testo 845 (0563 8450)	0636 9784
Plug-in mains adapter, 5 VDC 500 mA with European adapter, 100-250 VAC, 50-60 Hz	0554 0447
External fast charger for 1-4 AA rech. batteries, incl. 4 Ni-MH rech. batteries with individual cell charging and charge control display, incl. impulse trickle charging, integrated discharge function, with built-in international mains plug, 100-240 V, 300 mA, 50/60 Hz	0554 0610
Testo fast printer with wireless infrared interface, 1 roll thermal paper and 4 AA batteries, for printing out measurements on site	0554 0549
Spare thermal paper for printer (6 rolls), measurement data documentation legible for up to 10 years	0554 0568
testo saline pots for control and humidity adjustment of humidity probes, 11.3 %RH and 75.3 %RH with adapter for humidity probe	0554 0660
Adhesive tape, e.g. for bare surfaces (roll, L.: 10 m, W.: 25 mm), E = 0.95, temperature resistant to +250 °C	0554 0051
Silicone heat paste (14g), T _{max} = +260°C, improves heat transfer in surface probes	0554 0004
ISO calibration certificate/temperature, infrared thermometer; calibration points +60°C; +120°C; +180°C	0520 0002
ISO calibration certificate/temperature, Infrared thermometers, calibration points -18°C, 0°C, +60°C	0520 0401

Far-field measurement

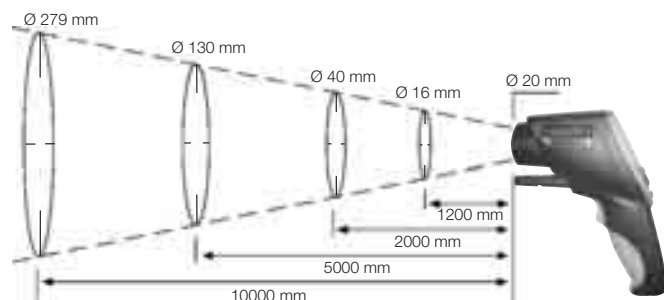

Probe socket for TC probes for determining emissivity

Aluminium case for instrument and accessories (included)



Reliable measurement in incoming goods, even of small products

Technical data	Infrared	Contact (type K)	Humidity module
Meas. range	-35 to +950 °C	-35 to +950 °C	0 to +100 %RH 0 to +50 °C -20 to +50 °C td
Accuracy ±1 digit	±2.5 °C (-35 to -20.1 °C) ±1.5 °C (-20 to +19.9 °C) ±0.75 °C (+20 to +99.9 °C) ±0.75% of mv (+100 to +950 °C)	±0.75 °C (-35 to +75 °C) ±1% of mv (+75.1 to +950 °C)	±2 %RH (2 to 98 %RH) ±0.5 °C (+10 to +40 °C) ±1 °C (remaining range)
Resolution	0.1 °C	0.1 °C	0.1 °C td
Emission factor	Adjustable 0.1 to 1.0		
Optical resolution	Far-field: (75:1) 16 mm, 1200 mm distance (90%) Close focus: 1 mm, 70 mm distance (90%)		
Measuring rate	t ₉₅ : 250 ms; Scanning Max/Min/Alarm: 100 ms		
Dimensions	155 x 58 x 195 mm		
Battery type	2 AA batteries		
Battery life	25 h (without laser), 10 h (with laser without light), 5 h (with laser and 50% light)		
Material/Housing	ABS Black/gray, metal screen		
Oper. temp.	-20 to +50 °C		
Storage temp.	-40 to +70 °C		

Close focus measurement

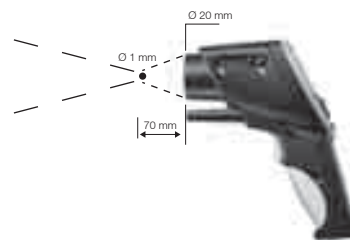

Switch to far-field measurement at a measurement distance > 250 mm.



testo Saveris™ – Measurement data monitoring in the food industry

In restaurants, food retail and in large kitchens, the cold chain must be guaranteed at all times. In order to keep foodstuffs fresh and to adhere to hygiene requirements, the uninterrupted documentation of the cold chain is necessary. testo Saveris provides optimum support here.

testo Saveris automates the monitoring of the cooling chain and thus provides you with security and time savings.

Should a limit value be exceeded, testo Saveris immediately issues an alarm. Various alarm options can be set based on your wishes. You thus receive not only uninterrupted documentation, but also will be informed immediately if the temperatures are outside the prescribed range.



The testo Saveris wireless probes stand out thanks to their easy, fully automatic commissioning and absolutely safe transfer of measurement data.



The testo Saveris base saves all measurement values in its long-term memory, and sends optical and audible alarm reports, e.g. by SMS.



Now new!

The testo analog coupler enables the integration of all transmitters with standardized current/voltage interfaces, e. g. 4 to 20 mA



The network-capable testo Saveris software offers a central overview of the measurement data, and uninterrupted documentation.

Conforms to important standards in the food industry (HACCP and EN 12830)

Note on the radio frequencies

868 MHz: EU countries and certain other countries (e.g. CH, NOR)

2.4 GHz: non-EU countries (country list can be called up under www.testo.com/saveris)



testo Saveris™ System overview

testo Saveris radio probe

Probe versions with internal and external temperature and humidity sensors allow the adaptation to every application. The radio probes are available with or without a display as an option. The memory in the probe ensures that the measurement data is not lost in the event of an interference in the radio link. Current measurement data, the battery status and the quality of the radio link are shown in the display.

testo Saveris router

The radio link can be improved or lengthened with poor structural conditions by using a router. Naturally several routers are possible in the testo Saveris system, but several routers are not connected in series.

Through the connection of a converter to an Ethernet jack, the signal of a radio probe can be converted into an Ethernet signal. This combines the flexible connection of the radio probe with the use of the existing Ethernet even over long transmission paths.



testo Saveris analog coupler

The analog coupler allows the inclusion of further measurement parameters into the testo Saveris monitoring system, by integrating all transmitters with standardized current/voltage interfaces, e. g. 4 to 20 mA or 0 to 10 V.

testo Saveris™ System overview

testo Saveris base

The base is the heart of testo Saveris and can save 40,000 readings per measurement channel independent of the PC. This corresponds to around one year of memory capacity at a measuring rate of 15 minutes. The system data and alarms are visible via the display of the Saveris base.

testo Saveris software

The testo Saveris software offers simple operation and an intuitive user interface. The Saveris software is available in two different versions: as the basic version SBE (Small Business Edition) or the PROF (Professional) software version with diverse additional options, or as a CFR version. The CFR software fulfils the requirements of 21 CFR Part 11 of the FDA, and is thus validatable.







Overview of software versions	SBE	PROF	CFR
Simple installation and configuration	•	•	•
Diagrams/tables/alarm overview/PDF reports	•	•	•
Calendar management	•	•	•
Representation of probe groups	•	•	•
Transmission of alarms (e-mail, SMS, relay)	•	•	•
Comprehensive alarm management		•	•
Automatic refresh of measurement data ("Online mode")		•	•
Measurement data on background photo of locations		•	•
Integration into network (client server)		•	•
Conform to 21CFR11 (validatable)			•
Electronic signature			•
Audit trail			•
Allocation of access rights on 3 user levels			•



testo Saveris™ Components: Radio probes

Probe versions with internal and external temperature sensors and with humidity sensors allow the adaptation to every application. The radio probes are available with or without a display as an option. Current measurement data, the battery status and the quality of the radio link are shown in the display.

		°C / °F						
		NTC internal	NTC internal	NTC external	TC external	Pt 100 external		
Radio		Saveris T1 Radio probe with internal NTC		Saveris T2 Radio probe with external probe connection and internal NTC, door contact		Saveris T3 2-channel radio probe with 2 external TC probe connections (Choice of TC characteristics)		Saveris Pt Radio probe with 1 external Pt100 probe connection
								
Internal sensor	Probe type	NTC	NTC					
	Meas. range	-35 to +50 °C	-35 to +50 °C					
	Accuracy	±0.4 °C (-25 to +50 °C) ±0.8 °C (remaining range)	±0.4 °C (-25 to +50 °C) ±0.8 °C (remaining range)					
	Resolution	0.1 °C	0.1 °C					
External probe	Probe type		NTC	TC type K	TC type J	Pt100		
	Meas. range (Instrument)		-50 to +150 °C	-195 to +1350 °C	-100 to +750 °C	-200 to +600 °C		
	Accuracy (Instrument)		±0.2 °C (-25 to +70 °C) ±0.4 °C (remaining range)	±0.5 °C or 0.5% of mv	TC type T	TC type S	at 25 °C ±0.1 °C (0 to +60 °C) ±0.2 °C (-100 to +200 °C) ±0.5 °C (remaining range)	
	Resolution (Instrument)		0.1 °C	0.1 °C / TC type S 1 °C	0 to +1760 °C	0.01 °C		
Conn.			NTC via mini-DIN socket, door contact connection cable included in delivery (1.80 m)	2 TCs via TC socket, max. difference in potential 2 V		1 Pt100 via mini-DIN socket		
Dimensions (housing):	80 x 85 x 38 mm							
Weight	Approx. 240 g							
Battery life (Type: 4 AA batteries)	Battery life at +25 °C, 3 years; for freezer applications, 3 years with L91 Photo lithium Energizer batteries)							
Material/Housing	Plastic							
Protection class	IP68		IP54		IP68			
Radio frequency	868 MHz / 2.4 GHz							
Measuring rate	Standard 15 min, 1 min to 24 h can be set							
Conformity with standards	DIN EN 12830							
Oper. temp.	-35 to +50 °C			-20 to +50 °C				
Storage temp.	-40 to +55 °C							
Display (optional)	LCD, 2 lines; 7-segment with symbols							
Transmission distance	approx. 300 m free field at a frequency of 868 MHz, approx. 100 m free field at a frequency of 2.4 GHz							
Wall bracket	included							

Ordering data Wireless probes	Part no.		Part no.	
	Version without display		Version with display	
	868 MHz	2.4 GHz	868 MHz	2.4 GHz
Saveris T1 Radio probe with internal NTC	0572 1110	0572 1150	0572 1120	0572 1160
Saveris T2 Radio probe with external probe connection and internal NTC, door contact	0572 1111	0572 1151	0572 1121	0572 1161
Saveris T3 2-channel radio probe with 2 external TC probe connections (Choice of TC characteristics)	0572 9112	0572 9152	0572 9122	0572 9162
Saveris Pt Radio probe with 1 external Pt100 probe connection	0572 7111	0572 7151	0572 7121	0572 7161

The alkali manganese batteries AA (0515 0414) are included in these ordering data (analog coupler excluded). Saveris probes are delivered with a calibration protocol of the factory adjustment data. Calibration certificates must be ordered separately.

testo Saveris™ Components: Radio probes



Radio

		°C / °F and %RH				mA and V	
		%RH	NTC	%RH	NTC	%RH	NTC
		external		internal		internal	
		Saveris H2D Wireless humidity probe		Saveris H3 Humidity radio probe		Saveris H4D Wireless probe with 1 external humidity probe connection	
						Saveris U1 Wireless probe with current/voltage output	
Internal sensor	Probe type			NTC	Humidity sensor		
	Meas. range			-20 to +50 °C	0 to 100 %RH		
	Accuracy			±0.5 °C	±3 %RH		
	Resolution			0.1 °C	0.1 °C / 0.1 °C td		
External probe	Probe type	NTC	Humidity sensor		NTC	Humidity sensor	
	Meas. range (Instrument)	-20 to +50 °C	0 to +100 %RH*		-20 to +70 °C	0 to +100 %RH*	
	Accuracy (Instrument)	±0.5 °C	to 90 %RH: ±2 %RH > 90 %RH: ±3 %RH		±0.2 °C	see probes	
	Resolution (Instrument)	0.1 °C	0.1% / 0.1 °C td		0.1 °C	0.1% / 0.1 °C td	
Conn.	non-exchangeable stump probe					1 x external humidity probe mini DIN socket	2 or 4-wire current/voltage output Service interface mini DIN for adjustment
Dimensions (housing):	85 x 100 x 38 mm			80 x 85 x 38 mm			Approx. 85 x 100 x 38 mm
Weight	Approx. 256 g			Approx. 245 g			Approx. 240 g
Battery life (Type: 4 AA batteries)	Battery life at +25 °C, 3 years; for freezer applications, 3 years with L91 Photo lithium Energizer batteries)						Supply: Mains unit 6.3 V DC, 2 to 30 V DC max. 25 V AC
Material/Housing	Plastic						
Protection class	IP54		IP42		IP54		
Radio frequency	868 MHz / 2.4 GHz						
Measuring rate	Standard 15 min, 1 min to 24 h can be set						
Oper. temp.	-20 to +50 °C						
Storage temp.	-40 to +55 °C						
Display (optional)	LCD, 2 lines; 7-segment with symbols					(no display)	
Transmission distance	approx. 300 m free field at a frequency of 868 MHz, approx. 100 m free field at a frequency of 2.4 GHz						
Wall bracket	included						

*not for continuous high-humidity applications

Ordering data Wireless probes	Part no.		Part no.	
	Version without display		Version with display	
	868 MHz	2.4 GHz	868 MHz	2.4 GHz
Saveris H3 Wireless probe with internal humidity sensor	0572 6110	0572 6150	0572 6120	0572 6160
Saveris H2D Wireless probe with external humidity sensor 2%RH, radio frequency 868 MHz (with display)			0572 6122	0572 6162
Saveris H4D Wireless humidity probe with external probe connection, radio frequency 868 MHz (with display)			0572 6124	0572 6164
Saveris U1 Analogkoppler with 1 current/voltage output (order mains unit separately)	0572 3110	0572 3150		

The alkali manganese batteries AA (0515 0414) are included in these ordering data (analog coupler excluded). Saveris probes are delivered with a calibration protocol of the factory adjustment data. Calibration certificates must be ordered separately.



testo Saveris™ Components: Base, Router, Converter and accessories

Base	Part no.	Saveris router	Part no.
Saveris base, radio frequency 868 MHz	0572 0120	Saveris router, 868 MHz, radio transmission medium	0572 0119
Saveris base, radio frequency 868 MHz, GSM module integrated (for SMS alarm)	0572 0121	Saveris router, 2.4 GHz, radio transmission medium	0572 0159
Saveris base, radio frequency 2.4 GHz	0572 0160	Saveris converter	Part no.
Saveris base, radio frequency 2.4 GHz, GSM module integrated (for SMS alarm)	0572 0161	Saveris converter, 868 MHz, converts the radio transmission medium to Ethernet	0572 0118
No mains units or aerials with magnetic base are contained in this ordering data.		Saveris converter, 2.4 GHz, converts the radio transmission medium to Ethernet	0572 0158
		No mains units are contained in this ordering data.	
Power supply	Part no.	Software	Part no.
Battery for radio probe (4 AA alkali manganese mignon batteries)	0515 0414	SBE software, incl. USB connecting cable base-PC	0572 0180
Battery for radio probe for use below -10 °C (4 Energizer L91 Photo lithium)	0515 0572	PROF software, incl. USB connecting cable base-PC	0572 0181
100-240 V AC / 6.3 V DC international mains unit for mains operation or battery charging in instrument	0554 1096	CFR software, incl. Ethernet connection cable PC to Base	0572 0182
Mains unit (top-hat rail mounting) 90 to 264 VAC/24 VDC (2.5 A)	0554 1749	Saveris adjustment software incl. connection cable for wireless and Ethernet probes	0572 0183
Mains unit (desk-top) 110 to 240 VAC/24 VDC (350mA)	0554 1748	Calibration Certificates	Part no.
Other features	Part no.	ISO calibration certificate/temperature Temperature probes; calibration points -8 °C; 0 °C; +40 °C per channel/instrument (suitable for Saveris T1/T2)	0520 0171
Magnetic foot aerial (dualband) with 3 m cable, for base with GSM module (not suitable for USA, Canada, Chile, Argentina, Mexico)	0554 0524	ISO calibration certificate/temperature Temperature probes; calibration points -18 °C; 0 °C; +60 °C; per channel/instrument (not suitable for Saveris T1/T2)	0520 0151
Magnetic foot aerial (quadband) for base with GSM module	0554 0525	DKD calibration certificate/temperature Temperature probes; calibration points -20 °C; 0 °C; +60 °C; per channel/instrument (not suitable for Saveris T1/T2)	0520 0261
Alarm module (visual + acoustic), can be connected to base alarm relay, Ø 70 x 164 mm, 24 V AC/DC / 320 mA, perm. light: red, perm. tone: buzzer approx. 2.4 kHz (Mains unit 0554 1749 required)	0572 9999 ID-Nr. 0699 6111/1	ISO calibration certificate humidity Humidity probe, calibration points 11.3 %RH and 75.3 %RH at +25 °C/+77 °F; per channel/instrument	0520 0076
Programming adapter (from mini-DIN to USB) for Ethernet probe and converter (necessary if no DHCP server available)	0440 6723	DKD calibration cert./humidity Humidity probe, calibration points 11.3 %RH and 75.3 %RH at +25 °C; per channel/instrument	0520 0246

Alarm module



Alarm module (visual + acoustic), can be connected to base alarm relay, Ø 70 x 164 mm, 24 V AC/DC / 320 mA, perm. light: red, perm. tone: buzzer approx. 2.4 kHz (Mains unit 0554 1749 required)
ID-Nr. 0699 6111/1

Part no. 0572 9999

Software versions



SBE software, incl. USB connecting cable base-PC

Part no. 0572 0180

PROF software, incl. USB connecting cable base-PC

Part no. 0572 0181

CFR software, incl. Ethernet connection cable PC to Base

Part no. 0572 0182

Sintered caps for probes Saveris H1 E, H2 E and H2 D

	Illustration	Part no.
Metal protective cap (open), fast reaction time at flow velocities < 7 m/s (not suitable for dusty atmospheres), for measurement in flow velocities of less than 10 m/s		0554 0755
Stainless steel sintered filter, pore size 100 µm, probe protection in dusty atmospheres or higher flow velocities, for measurements at higher flow velocities or in contaminated air		0554 0647
Wire mesh filter, probe protection from coarse particles		0554 0757
Sintered PTFE filter, Ø 12 mm, for corrosive media, High humidity range (long-term measurements), high flow velocities.		0554 0756
testo saline pots for control and humidity adjustment of humidity probes, 11.3 %RH and 75.3 %RH with adapter for humidity probe, quick checks or calibration of humidity probe		0554 0660

testo Saveris™ Technical data







Technical data	
	Saveris-Base
Memory	40,000 values per channel (total max. 10,160,000 values)
Dimensions	225 x 150 x 49 mm
Weight	Approx. 1510 g
Protection class	IP42
Material/Housing	Diecast zinc / plastic
Radio frequency	868 MHz / 2.4 GHz
Power supply (absolutely necessary)	6.3 V DC mains unit; alternatively via 24 V AC/DC plug-in/screw terminals, power consumption < 4 W
Rech. batt.	Li-ion battery (for data back-up and for emergency SMS if power supply fails)
Oper. temp.	-10 to +50 °C
Storage temp.	-40 to +60 °C
Display	graphical display, 4 control keys
Interfaces	USB, radio, Ethernet
Connectable radio probe	max. 15 probes can be directly connected via radio interface, max. 150 total via radio / router / converter / Ethernet, max. 254 channels
Alarm relay	max. 1 A, max. 30 W, max. 60/25 V DC/AC, NC or NO contact
GSM module	850 / 900 / 1800 / 1900 MHz not valid for Japan and South Korea
Set up	Table base and wall bracket included

Technical data		
	Saveris router	Saveris converter
Dimensions	Approx. 85 x 100 x 38 mm	Approx. 85 x 100 x 35 mm
Weight	Approx. 180 g	Approx. 190 g
Power supply	6.3 V DC mains unit; alternatively via 24 V AC/DC plug-in/screw terminals, power consumption < 0.5 W	6.3 V DC mains unit; alternatively via 24 V AC/DC plug-in/screw terminals, PoE, power consumption < 2 W
Oper. temp.	-20 to +50 °C	-20 to +50 °C
Storage temp.	-40 to +60 °C	-40 to +60 °C
Material/Housing	Plastic	Plastic
Protection class	IP54	IP54
Interfaces	Radio	Radio, Ethernet
Connectable radio probe	max. 5	max. 15
Wall bracket	included	included

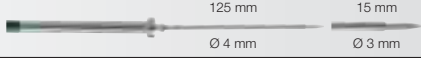
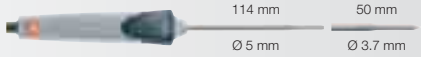

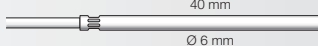
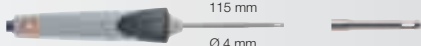
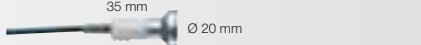

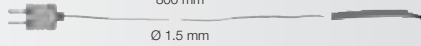
testo Saveris™ Accessories: External temperature probes

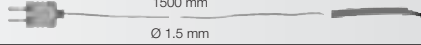
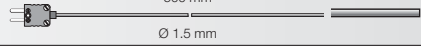
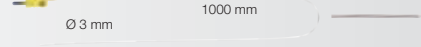
Pt100	Plug-in probes	Illustration	Meas. range	Accuracy	t99	Part no.
	Robust, Pt100 stainless steel food probe (IP65)	 125 mm 15 mm Ø 4 mm Ø 3 mm	-50 to +400 °C	Class A (-50 to +300 °C), Class B (remaining range)	10 s	0609 2272 Conn.: Fixed cable
	Robust, waterproof Pt100 immersion/penetration probe	 114 mm 50 mm Ø 5 mm Ø 3.7 mm	-50 to +400 °C	Class A (-50 to +300 °C), Class B (remaining range)	12 s	0609 1273 Conn.: Fixed cable
	Connection cable for unlimited Pt100 stationary probes with screw terminals (4-wire technology), max. cable length: 20 m					0554 0213

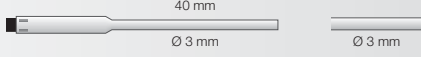
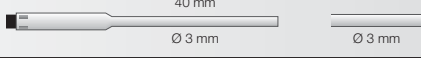
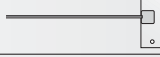
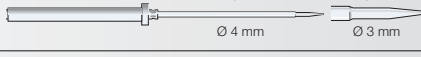
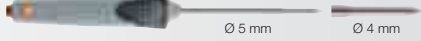

TC	Plug-in probes	Illustration	Meas. range	Accuracy	t99	Part no.
	Stationary probe with stainless steel sleeve, TC Type K	 40 mm Ø 6 mm	-50 to +205 °C	Class 2 ¹	20 s	0628 7533 Conn.: Fixed cable 1.9 m
	Robust air probe, T/C Type K	 115 mm Ø 4 mm	-60 to +400 °C	Class 2 ¹	25 s	0602 1793 Conn.: Fixed cable 1.2 m
	Magnetic probe, adhesive force approx. 20 N, with magnets, for measurements on metal surfaces, TC Type K	 35 mm Ø 20 mm	-50 to +170 °C	Class 2 ¹	150 s	0602 4792 Conn.: Fixed cable
	Magnetic probe, adhesive force approx. 10 N, with magnets, for higher temp., for measurements on metal surfaces, TC Type K	 75 mm Ø 21 mm	-50 to +400 °C	Class 2 ¹		0602 4892 Conn.: Fixed cable 1.6 m
	Thermocouple with TC adapter, flexible, 800mm long, fibre glass, TC Type K	 800 mm Ø 1.5 mm	-50 to +400 °C	Class 2 ¹	5 s	0602 0644
	Thermocouple with TC adapter, flexible, 1500mm long, fibre glass, TC Type K	 1500 mm Ø 1.5 mm	-50 to +400 °C	Class 2 ¹	5 s	0602 0645
	Thermocouple with TC adapter, flexible, 1500mm long, PTFE, TC Type K	 1500 mm Ø 1.5 mm	-50 to +250 °C	Class 2 ¹	5 s	0602 0646
	Immersion tip, flexible, TC Type K	 500 mm Ø 1.5 mm	-200 to +1000 °C	Class 1 ¹	5 s	0602 5792
	Immersion measurement tip, flexible, for measurements in air/exhaust gases (not suitable for measurements in smelters), TC Type K	 Ø 3 mm 1000 mm	-200 to +1300 °C	Class 1 ¹	4 s	0602 5693

¹According to standard EN 60584-2, the accuracy of Class 1 refers to -40 to +1000 °C (Type K), Class 2 to -40 to +1200 °C (Type K), Class 3 to -200 to +40 °C (Type K).

NTC	Plug-in probes	Illustration	Meas. range	Accuracy	t99	Part no.
	Stub probe, IP 54	 35 mm Ø 3 mm	-20 to +70 °C	±0.2 °C (-20 to +40 °C) ±0.4 °C (+40.1 to +70 °C)	15 s	0628 7510
	Stationary probe with aluminium sleeve, IP 65	 40 mm Ø 6 mm	-30 to +90 °C	±0.2 °C (0 to +70 °C) ±0.5 °C (remaining range)	190 s	0628 7503* Conn.: Fixed cable 2.4 m
	Accurate imm./pen. probe, 6m cable, IP 67	 40 mm Ø 3 mm Ø 3 mm	-35 to +80 °C	±0.2 °C (-25 to +74.9 °C) ±0.4 °C (remaining range)	5 s	0610 1725* Conn.: Fixed cable 6 m
	Accurate immersion/penetration probe, cable: 1.5 m long, IP 67	 40 mm Ø 3 mm Ø 3 mm	-35 to +80 °C	±0.2 °C (-25 to +74.9 °C) ±0.4 °C (-35 to -25.1 °C) ±0.4 °C (+75 to +80 °C)	5 s	0628 0006* Conn.: Fixed cable 1.5 m
	Wall surface temperature probe, e.g. to prove damage in building material		-50 to +80 °C	±0.2 °C (0 to +70 °C)	20 s	0628 7507 Conn.: Fixed cable 3 m
	Stainless steel NTC food probe (IP65) with PUR cable	 125 mm 15 mm Ø 4 mm Ø 3 mm	-50 to +150 °C ²⁾	±0.5% of mv (+100 to +150 °C) ±0.2 °C (-25 to +74.9 °C) ±0.4 °C (remaining range)	8 s	0613 2211* Conn.: Fixed cable 1.6 m
	Waterproof NTC immersion/penetration probe	 115 mm 50 mm Ø 5 mm Ø 4 mm	-50 to +150 °C	±0.5% of mv (+100 to +150 °C) ±0.2 °C (-25 to +74.9 °C) ±0.4 °C (remaining range)	10 s	0613 1212 Conn.: Fixed cable 1.2 m

* Probe tested to EN 12830 for suitability in the transport and storage sectors

2) Long-term meas. range +125°C, short-term +150°C (2 minutes)

%RH	Plug-in probes	Illustration	Meas. range	Accuracy	Part no.
	Humidity / Temperature Probe 12mm	 Ø 12 mm	-20 to +70 °C, 0 to +100 %RH	±0.3 °C, ±2 %RH (2 to 98 %RH)	0572 6172
	Humidity / Temperature Probe 4 mm	 Ø 4 mm	0 to +40 °C, 0 to +100 %RH	±0.3 °C, ±2 %RH (2 to 98 %RH)	0572 6174

The specified accuracy class of the Saveris radio and Ethernet probe is achieved using these external probes.

testo Saveris™ Examples of applications



Temperature monitoring in specialist retailers and large-scale kitchens

The measurement data is saved centrally and can thus be called up at any time. It goes without saying that the testo Saveris conforms to the food standard EN 12830. Using this uninterrupted documentation that testo Saveris offers, you always play it safe when it comes to monitoring of your temperatures.



Easiest operation of testo Saveris

Sabine Steinbrunner, proprietor of food product market 'Culinara'



"I was very pleasantly surprised at how easy the installation and operation were."



Documentation and issuing alarms in bakeries and butcher shops

The uninterrupted monitoring of the cooling chain is required for food specialist retailers.

Fresh goods are required by the customer but are at the same time required by the legislation in the hygiene area.

testo Saveris automates the monitoring of the ambient and product temperatures in store rooms, cold rooms, freezer areas and cooled sales counters. Naturally an alarm is issued immediately whenever a limit value is exceeded, on site as well as remotely.



Automatic monitoring of the cooling chain saves time

Werner Schmidt, proprietor of butcher's shop 'Metzgerei Haller'



"With testo Saveris the temperature monitoring of the food practically runs itself. Now I have more time for the customers!"



Data loggers — Logging, saving, printing and analysing

What is the temperature really?



Wolfgang Schwörer,
Head of Product
Development
Portable and
Systems

How can you be sure that your analyser measures exactly what it should be measuring? Our certified DKD laboratories are unbeatable in their accuracy and give the

values for all Testo measuring instruments - That's what true measurement efficiency is all about.

The competence of our engineers is held in high esteem by expert groups and committees in Berlin and Brussels where they are involved in the developments of future guidelines in their capacity as representatives of industry.

A comprehensive exchange of knowledge and experience with official measurement institutes around the world (e.g. DKD) ensures that your Testo measuring instrument can hold up to any comparison. Indeed, these efforts do have an objective: whoever uses Testo measurement engineering, can be assured that he is using the industrial standard.

Of further benefit to you: We know today about the guidelines and test specifications we will be faced with in the future.



On site: Fast printout on the testo 575 printer



testo 580 data collector collects and transmits data on site to PC



testo 581 alarm signal output for reliable warning of limits exceeded



Wall holder with lock for tamper-proof installation on site



Monitor storage temperature – Small and practical

testo 174

The testo 174 mini data logger is ideal for accompanying transports as it can unobtrusively monitor temperature fluctuations non-stop. The current reading is shown in the display.

The following can be called up: Stored minimum and maximum value, limit values and battery life.

- Accurate, punctual temperature logging with up to 3900 readings
- Alarm display if user-defined maximum/minimum values are exceeded
- Software to read out data, data analysis and parameter setting
- Secure data even if battery is spent

testo 174

Mini temperature data logger, 1 channel, incl. wall holder, lock and battery

Part no. 0563 1741

Technical data

Meas. range	-30 to +70 °C
Data loggers	3900 readings
Measuring rate	1 min to 4 h (selectable)
Battery life	500 days (typical)
Analysis software	MS Windows 95b / 98 / ME / 2000 / XP / Vista
Dimensions	55 x 35 x 14 mm
Weight	24 g

testo 174, Starter Set

Mini temperature data logger, 1 channel, ComSoft 4 Basic, wall holder, lock, interface incl. PC connection cable (RS232), battery

Part no. 0563 1742

testo 174, USB Set

Mini temperature data logger, 1 channel, ComSoft 4 Basic, wall holder, USB interface with PC connection cable and battery

Part no. 0563 1743



Tamper-proof installation on site



Data upload to PC or notebook via interface (optional)



Checks food e.g. in refrigerated storerooms, during transport, in containers etc.

Accessories Ordering data

Accessories Ordering data	Part no.
Lithium battery, button cell, type CR 2032	0515 0028
ISO calibration certificate/temperature, temperature data logger, calibration points -18°C, +60°C	0520 0443
USB interface, suitable for testo 174 data logger, incl. PC connection cable	0554 1739

Document storage temperature – Fast and easy

testo 175-T1

The 175-T1 temperature data logger guarantees uninterrupted documentation with up to 7800 readings

- Provides quick overview of current reading, last value saved, max/min value, number of times limits exceeded
- Secure data even if battery is empty

- On site: Collect data with testo 580 and upload to PC for analysis

testo 175-T1

Internal °C
testo 175-T1, temperature data logger, 1 channel with internal sensor, incl. wall holder and calibration protocol; calibration certificates (ISO/DKD) must be ordered separately

Part no. 0563 1754



Data is printed on site on the fast testo 575 printer (optional)



Records temperature fluctuations e.g. during storage and transport of meat – in the context of quality assurance

Technical data

Chann. intern	1
Probe type	NTC
Meas. range	-35 to +70 °C
Accuracy ±1 digit	±0.5 °C (-20 to +70 °C) ±1 °C (-35 to -20.1 °C)
Resolution	0.1 °C (-20 to +70 °C) 0.3 °C (-35 to -20.1 °C)
Memory	7800 Measuring rate 10 s ... 24 h
Battery life	2.5 years at meas. rate of 15 min (-10 to +50 °C)
Analysis software	MS Windows 95b / 98 / ME / 2000 / XP / Vista
Dimensions	82 x 52 x 30 mm
Weight	90 g Protection class IP68

Recommended Set: Starter Set

testo 175-T1, temperature data logger, 1 channel with internal sensor, incl. wall holder and calibration protocol; calibration certificates (ISO/DKD) must be ordered separately	0563 1754
Lock for wall holder for testo 175/177 data loggers	0554 1755
ComSoft 4 Set - Basic with USB interface, Basic software with diagram and table function, incl. desk-top holders, PC connection cable	0554 1766

Accessories Ordering data see page 49



Log temperature – Simultaneously at two sites

testo 175-T2

With an additional external probe socket, the temperature data logger provides a further temperature measurement option.

testo 175-T2

Internal °C + external °C

testo 175-T2, temperature data logger, 2 channels, with internal sensor and external probe socket, wall holder and calibration protocol; calibration certificates (ISO/DKD) must be ordered separately

Part no. 0563 1755

- Monitors 2 temperatures simultaneously
- Fast overview of current reading, last value saved, max/min values, number of times limits exceeded
- User-friendly operation, convenient analysis



Collects data on site, uploads to PC and analyses



Tamper-proof with wall holder and lock (optional)

Simultaneous monitoring of product and air temperature e.g. in refrigerated storerooms, containers etc.

Technical data

Chann. intern	1	
Meas. range	-35 to +70 °C	
Accuracy ±1 digit	±0.5 °C (-20 to +70 °C)	±1 °C (remaining range)
Resolution	0.1 °C (-20 to +70 °C)	0.3 °C (remaining range)
Chann. external (var.)	1	
Meas. range	-40 to +120 °C	
Accuracy ±1 digit	±0.3 °C (-25 to +70 °C)	±0.5 °C (remaining range)
Resolution	0.1 °C (-25 to +70 °C)	0.3 °C (remaining range)
Battery life	2.5 years at a meas. rate of 15 min (-10 to +50 °C)	
Analysis software	MS Windows 95b / 98 / ME / 2000 / XP / Vista	
Memory	16000	Measuring rate 10 s to 24 h
Oper. temp.	-35 to +70 °C	Storage temp. -40 to +85 °C
Protection class	IP68	Dimensions 82 x 52 x 30 mm
Weight	84 g	

Recommended Set: testo 175-T2, Starter Set

testo 175-T2, temperature data logger, 2 channels, with internal sensor and external probe socket, wall holder and calibration protocol; calibration certificates (ISO/DKD) must be ordered separately	0563 1755
Lock for wall holder for testo 175/177 data loggers	0554 1755
Stationary probe with aluminium sleeve, IP 65	0628 7503
ComSoft 4 Set - Basic with USB interface, Basic software with diagram and table function, incl. desk-top holders, PC connection cable	0554 1766

See Page 49 for Accessories Ordering Data

Description	Illustration	Meas. range	Accuracy	t99	Part no.
Stub probe, IP 54		-20 to +70 °C	±0.2 °C (-20 to +40 °C) ±0.4 °C (+40.1 to +70 °C)	15 s	0628 7510
Stationary probe with aluminium sleeve, IP 65		-30 to +90 °C	±0.2 °C (0 to +70 °C) ±0.5 °C (remaining range)	190 s	0628 7503* Conn.: Fixed cable
Accurate imm./pen. probe, 6m cable, IP 67		-35 to +80 °C	±0.2 °C (-25 to +74.9 °C) ±0.4 °C (remaining range)	5 s	0610 1725* Conn.: Fixed cable
Accurate immersion/penetration probe, cable: 1.5 m long, IP 67					0628 0006*
Probe for surface measurement		-50 to +80 °C	±0.2 °C (0 to +70 °C)	150 s	0628 7516* Conn.: Fixed cable
Stainless steel NTC food probe (IP65) with PUR cable		-50 to +150 °C Long-term meas. range +125 °C, short-term +150 °C (2 minutes)	±0.5% of mv (+100 to +150 °C) ±0.2 °C (-25 to +74.9 °C) ±0.4 °C (remaining range)	8 s	0613 2211* Conn.: Fixed cable
Robust NTC food penetration probe with special handle, reinforced PUR cable		-25 to +150 °C Long-term meas. range +125 °C, short-term +150 °C (2 minutes)	±0.5% of mv (+100 to +150 °C) ±0.2 °C (-25 to +74.9 °C) ±0.4 °C (remaining range)	7 s	0613 2411* Conn.: Fixed cable
Frozen food probe NTC, corkscrew design (incl. plug-in wire)		-50 to +140 °C Long-term meas. range +125 °C, short-term +140 °C (2 minutes)	±0.5% of mv (+100 to +140 °C) ±0.2 °C (-25 to +74.9 °C) ±0.4 °C (remaining range)	20 s	0613 3211* Conn.: Plug-in cable
Efficient, robust NTC air probe		-50 to +125 °C Long-term meas. range +125 °C, short-term +150 °C	±0.2 °C (-25 to +80 °C) ±0.4 °C (remaining range)	60 s	0613 1712 Conn.: Fixed cable

□ The specified seal class of the data loggers is achieved with these probes.

* Probe tested to EN 12830 for suitability in the transport and storage sectors

Monitor ambient storage conditions – Reliably and efficiently

testo 175-H1

The affordable humidity/temperature logger testo 175-H1 without display monitors fluctuations in storage humidity and temperature efficiently and unobtrusively.

Limit values can be entered, an alarm display is activated if the limits are exceeded. testo 575, the fast printer, supplies proof of fluctuations in ambient conditions.

- Humidity sensor guaranteed long-term stable
- Memory for up to 3700 readings (testo 175-H1)
- Memory for up to 16000 readings (testo 175-H2)
- Data safe even when battery is spent
- Fast documentation on infrared printer, 6 lines/s
- Data transfer to PC or Notebook via interface or testo 580 data collector
- Large display (testo 175-H2)

testo 175-H2

The compact humidity/temperature logger with display. It provides you with a fast on-site overview of current readings, the last values saved, max and min values and the number of times limits were exceeded.

The testo 575 fast printer provides proof that the specified ambient storage conditions or production conditions have been adhered to. All of the values logged by the testo 580 data collector can then be uploaded to your PC for analysis.

testo 175-H1 without display. Data is printed on the fast printer.

Data analysis with easy-to-use Windows® software



testo 175-H2, transport and ambient storage conditions logging with immediate display of limits exceeded

testo 175-H1 w/o display

Internal %RH, °C

testo 175-H1, humidity/temperature logger, 2 channels, with internal sensors, wall holder and calibration protocol; calibration certificates (ISO/DKD) must be ordered separately

Part no. 0563 1757

testo 175-H2 with display

Internal %RH, °C

testo 175-H2, humidity/temperature logger, 2 channels, with internal sensors, wall holder and calibration protocol; calibration certificates (ISO/DKD) must be ordered separately

Part no. 0563 1758

Recommended Set: testo 175-H1, Starter set

testo 175-H1, humidity/temperature logger, 2 channels, with internal sensors, wall holder and calibration protocol; calibration certificates (ISO/DKD) must be ordered separately	0563 1757
Lock for wall holder for testo 175/177 data loggers	0554 1755
ComSoft 4 Set - Basic with USB interface, Basic software with diagram and table function, incl. desk-top holders, PC connection cable	0554 1766

Recommended Set: testo 175-H2, Starter Set

testo 175-H2, humidity/temperature logger, 2 channels, with internal sensors, wall holder and calibration protocol; calibration certificates (ISO/DKD) must be ordered separately	0563 1758
Lock for wall holder for testo 175/177 data loggers	0554 1755
ComSoft 4 Set - Basic with USB interface, Basic software with diagram and table function, incl. desk-top holders, PC connection cable	0554 1766

Technical data	testo 175-H1 w/o display	testo 175-H2 with display
Channels	2	2
Probe type	Testo humid. sensor, cap. NTC	Testo humid. sensor, cap. NTC
Meas. range	0 to +100 %RH* -10 to +50 °C	0 to +100 %RH* -20 to +70 °C
Accuracy ±1 digit	±3 %RH ±0.5 °C	±3 %RH ±0.5 °C
Resolution	0.1 %RH 0.1 °C	0.1 %RH 0.1 °C
Memory	3700	16000
Oper. temp.	-10 to +50 °C	-20 to +70 °C
Storage temp.	-40 to +70 °C	-40 to +85 °C
Weight	80 g	85 g
Dimensions	82 x 52 x 30 mm	82 x 52 x 30 mm
Battery life	2.5 years at a meas. rate of 15 min (-10 to +50 °C)	
Measuring rate	10 s to 24 h	10 s to 24 h
Software	MS Windows 95b / 98 / ME / 2000 / XP / Vista	

* not affected by condensation

See Page 49 for Accessories Ordering Data



Long-term temperature monitoring – Professional and non-stop

testo 177-T1

The professional testo 177-T1 data logger (without display) monitors specified storage and transport conditions in the refrigeration and deep-freeze sector efficiently and accurately over a period of months and years.

Temperature fluctuations which cause damage are documented on the testo 575 fast printer or analysed on your PC via interface.

- Logs temperatures with up to 48,000 readings
- Specially for use in low temperatures (up to $-40\text{ }^{\circ}\text{C}$)
- On-site: Fast documentation on the infrared printer, 6 lines/s
- Collect data on-site with testo 580 and download to your PC for analysis

testo 177-T2

testo 177-T2, the professional data logger with display. It provides you with a quick overview of the current reading, the last value saved, max and min values and the number of times the limits were exceeded.

All of the values collected by the testo 580 data collector during long-term monitoring over months/years can be sent to your notebook/PC. Convenient analysis possible using software based on Windows®.



testo 177-T1 without display, data is printed on site on the fast testo 575 printer



Collects data on site which is uploaded to PC for analysis



Long-term temperature logging with immediate display when limits are exceeded e.g. during transport, in refrigerated rooms, warehouses etc.



testo 177-T1 without display

testo 177-T1, temperature data logger, 1 channel, with internal sensor, wall holder and calibration; calibration certificates (ISO/DKD) must be ordered separately

Part no. 0563 1771

testo 177-T2 with display

testo 177-T2, temperature data logger, 1 channel, with internal sensor, wall holder and calibration protocol; calibration certificates (ISO/DKD) must be ordered separately

Part no. 0563 1772

Recommended Set: testo 177-T1, Starter Set

testo 177-T1, temperature data logger, 1 channel, with internal sensor, wall holder and calibration; calibration certificates (ISO/DKD) must be ordered separately	0563 1771
Lock for wall holder for testo 175/177 data loggers	0554 1755
ComSoft 4 Set - Basic with USB interface, Basic software with diagram and table function, incl. desk-top holders, PC connection cable	0554 1767

Recommended Set: testo 177-T2, Starter Set

testo 177-T2, temperature data logger, 1 channel, with internal sensor, wall holder and calibration protocol; calibration certificates (ISO/DKD) must be ordered separately	0563 1772
Lock for wall holder for testo 175/177 data loggers	0554 1755
ComSoft 4 Set - Basic with USB interface, Basic software with diagram and table function, incl. desk-top holders, PC connection cable	0554 1767

Technical data

		Probe type	NTC
Chann. intern	1		
Meas. range	-40 to $+70\text{ }^{\circ}\text{C}$	Resolution	$0.1\text{ }^{\circ}\text{C}$
Accuracy ± 1 digit	$\pm 0.4\text{ }^{\circ}\text{C}$ (-25 to $+70\text{ }^{\circ}\text{C}$)		$\pm 0.8\text{ }^{\circ}\text{C}$ (-40 to $-25.1\text{ }^{\circ}\text{C}$)
Measuring rate	2 s to 24 h	Memory	48000
Oper. temp.	-40 to $+70\text{ }^{\circ}\text{C}$	Storage temp.	-40 to $+85\text{ }^{\circ}\text{C}$
Dimensions	103 x 64 x 33 mm		
Weight	111 g (testo 177-T1)	122 g (testo 177-T2)	
Battery life	5 years at meas. cycle of 15 min (-10 to $+50\text{ }^{\circ}\text{C}$)		
Analysis software	MS Windows 95b / 98 / ME / 2000 / XP / Vista		

Accessories Ordering data see page 49

Service Warranty

"Authentic quality: one of Testo's major claims. Warranties of up to 3 years are proof of our lasting quality - this thoroughness has made us one of the leading manufacturers in the world."



Jörg Wittmer
Head of Customer Service

The truck data logger with 2 probe sockets and event logging

testo 177-T3

testo 177-T3 documents 3 temperatures and an event simultaneously providing proof of an uninterrupted cooling chain during transport.

For example, complete monitoring of ambient air, intake and outgoing temperature with simultaneous monitoring of the door or the compressor is possible when monitoring transport. The measuring rate of the event can be set completely independently of the measuring rate of the temperature channels.

- Temperature logging of up to 48000 readings
- Data is read out without interrupting the measurement series
- Data analysis as table or graph, with Email function

testo 177-T3

Internal °C + 2 x external °C + event contact

testo 177-T3, temperature data logger, 3 channels, with internal sensor, 2 probe sockets, door contact connection cable, wall holder and calibration protocol; calibration certificates (ISO/DKD) must be ordered separately

Part no. 0563 1773

Collect data on site, read out on your PC and analyse



Temperature monitoring at different sites e.g. during transport, in warehouses, in containers etc.

Technical data

Chann. intern 1		Chann. external (var.) 2	
Meas. range	-40 to +70 °C	Meas. range	-40 to +120 °C
Accuracy	±0.4 °C (-25 to +70 °C) ±1 digit	Accuracy	±0.2 °C (-25 to +70 °C) ±1 digit
Resolution	0.1 °C	Resolution	0.1 °C
Memory	48000	Battery type	Lithium battery
Oper. temp.	-40 to +70 °C	Weight	127 g
Storage temp.	-40 to +85 °C	Dimensions	103 x 64 x 33 mm

External: Event logging e.g. door contact
 Battery life: 5 years with meas. rate of 15 min (-10 to +50°C)
 Measuring rate: 2 s to 24 h
 Software: Microsoft Windows 95b / 98 / ME / NT4-Sp4 / 2000 / XP / Vista

See page 49 for Accessories Ordering Data

Recommended Set: Temperature monitoring with printout on-site

testo 177-T3, temperature data logger, 3 channels, with internal sensor, 2 probe sockets, door contact connection cable, wall holder and calibration protocol; calibration certificates (ISO/DKD) must be ordered separately	0563 1773
Lock for wall holder for testo 175/177 data loggers	0554 1755
Stationary probe with aluminium sleeve, IP 65	0628 7503
Stationary probe with aluminium sleeve, IP 65	0628 7503
Fast testo 575 printer, incl. 1 roll of thermal paper and batteries	0554 1775
ComSoft 4 Set - Basic with USB interface, Basic software with diagram and table function, incl. desk-top holders, PC connection cable	0554 1767

Description	Illustration	Meas. range	Accuracy	t99	Part no.
Stub probe, IP 54		-20 to +70 °C	±0.2 °C (-20 to +40 °C) ±0.4 °C (+40.1 to +70 °C)	15 s	0628 7510
Stationary probe with aluminium sleeve, IP 65		-30 to +90 °C	±0.2 °C (0 to +70 °C) ±0.5 °C (remaining range)	190 s	0628 7503* Conn.: Fixed cable
Accurate imm./pen. probe, 6m cable, IP 67		-35 to +80 °C	±0.2 °C (-25 to +74.9 °C) ±0.4 °C (remaining range)	5 s	0610 1725* Conn.: Fixed cable
Accurate immersion/penetration probe, cable: 1.5 m long, IP 67					0628 0006*
Probe for surface measurement		-50 to +80 °C	±0.2 °C (0 to +70 °C)	150 s	0628 7516* Conn.: Fixed cable
Stainless steel NTC food probe (IP65) with PUR cable		-50 to +150 °C	±0.5% of mv (+100 to +150 °C) ±0.2 °C (-25 to +74.9 °C) ±0.4 °C (remaining range)	8 s	0613 2211* Conn.: Fixed cable
Robust NTC food penetration probe with special handle, reinforced PUR cable		-25 to +150 °C	±0.5% of mv (+100 to +150 °C) ±0.2 °C (-25 to +74.9 °C) ±0.4 °C (remaining range)	7 s	0613 2411* Conn.: Fixed cable
Frozen food probe NTC, corkscrew design (incl. plug-in wire)		-50 to +140 °C	±0.5% of mv (+100 to +140 °C) ±0.2 °C (-25 to +74.9 °C) ±0.4 °C (remaining range)	20 s	0613 3211* Conn.: Plug-in cable
Efficient, robust NTC air probe		-50 to +125 °C Long-term meas. range +125 °C, short-term +150 °C	±0.2 °C (-25 to +80 °C) ±0.4 °C (remaining range)	60 s	0613 1712 Conn.: Fixed cable

□ The specified seal class of the data loggers is achieved with these probes.

* Probe tested to EN 12830 for suitability in the transport and storage sectors



Long-term monitoring of ambient conditions – Professional and non-stop

testo 177-H1

Sensitive products require the right ambient conditions during production and storage. Efficient measurement and documentation of the readings over months/years is possible with the testo 177-H1 professional data logger.

Additional surface, immersion and air probes can be attached to the data logger e.g. for uninterrupted measurement of the dewpoint difference.

- Long-term stable humidity sensor with fast response time
- Memory for 48,000 readings
- Control and adjustment option with adjustment set
- Protection caps for dirt-ingressed or corrosive gases

testo 177-H1

Intern. %RH, °C, °C td + extern. °C
testo 177-H1, humidity/temperature logger, 4 channels, with internal sensors and additional external temp. probe socket, wall holder and calibration protocol; calibration certificates (ISO/DKD) must be ordered separately

Part no. 0563 1775

Collect data on site, upload to PC and analyse

Alarm message, reliable notification when limits are exceeded

Efficient measurement of ambient conditions

Technical data

Chann. intern	3		
Meas. range	0 to +100 %RH	-20 to +70 °C	-40 to +70 °C td
Accuracy ±1 digit	±2 %RH	±0.5 °C	
Resolution	0.1 %RH	0.1 °C	0.1 °C td
Chann. external (var.)	1		
Meas. range	-40 to +120 °C		
Accuracy ±1 digit	±0.2 °C (-25 to +70 °C)	±0.4 °C (remaining range)	
Resolution	0.1 °C		
Memory	48000		
Measuring rate	2 s to 24 h	Protection class	IP54
Battery life	5 years at meas. rate of 15 min (-10 to +50 °C)		
Analysis software	MS Windows 95b / 98 / ME / 2000 / XP / Vista		
Oper. temp.	-20 to +70 °C	Storage temp.	-40 to +85 °C
Dimensions	103 x 64 x 33 mm	Weight	130 g

Recommended Set: Set for logging storage conditions and additional temperature measurement

testo 177-H1, humidity/temperature logger, 4 channels, with internal sensors and additional external temp. probe socket, wall holder and calibration protocol; calibration certificates (ISO/DKD) must be ordered separately	0563 1775
Lock for wall holder for testo 175/177 data loggers	0554 1755
Accurate imm./pen. probe, 6m cable, IP 67	0610 1725
testo 580 data collector set with RS232, readout holders included, for testo 175/177 data loggers	0554 1778
ComSoft 4 Set - Basic with USB interface, Basic software with diagram and table function, incl. desk-top holders, PC connection cable	0554 1767

See page 49 for Accessories Ordering data

Description	Illustration	Meas. range	Accuracy	t99	Part no.
Stub probe, IP 54		-20 to +70 °C	±0.2 °C (-20 to +40 °C) ±0.4 °C (+40.1 to +70 °C)	15 s	0628 7510
Stationary probe with aluminium sleeve, IP 65		-30 to +90 °C	±0.2 °C (0 to +70 °C) ±0.5 °C (remaining range)	190 s	0628 7503* Conn.: Fixed cable
Accurate imm./pen. probe, 6m cable, IP 67		-35 to +80 °C	±0.2 °C (-25 to +74.9 °C) ±0.4 °C (remaining range)	5 s	0610 1725* Conn.: Fixed cable
Accurate immersion/penetration probe, cable: 1.5 m long, IP 67					0628 0006*
Wall surface temperature probe, e.g. to prove damage in building material		-50 to +80 °C	±0.2 °C (0 to +70 °C)	20 s	0628 7507 Conn.: Fixed cable
Stainless steel NTC food probe (IP65) with PUR cable		-50 to +150 °C Long-term meas. range +125°C, short-term +150°C (2 minutes)	±0.5% of mv (+100 to +150 °C) ±0.2 °C (-25 to +74.9 °C) ±0.4 °C (remaining range)	8 s	0613 2211* Conn.: Fixed cable
Efficient, robust NTC air probe		-50 to +125 °C Long-term meas. range +125 °C, short-term +150 °C	±0.2 °C (-25 to +80 °C) ±0.4 °C (remaining range)	60 s	0613 1712 Conn.: Fixed cable

□ The specified seal class of the data loggers is achieved with these probes.

* Probe tested to EN 12830 for suitability in the transport and storage sectors

Accessories for testo 175 and 177

testo 575 fast printer

- Fast-action print mechanism, 6 lines/s
- Prints tables/graphics
- Brief info. or full memory can be printed as required
- Determine section to be printed
- Your language can be set
- Self-adhesive Testo paper can also be used



Fast printout and logger rebooting with testo 575

Part no. 0554 1775

testo 580 data collector

- Can read out up to 25 full testo 175 loggers or 10 full testo 177 loggers
- Displays all data information
- Download collected data to PC using Testo ComSoft 3



The testo 580 data collects data on site for upload to PC and analysis

testo 580 with RS232 interface

Part no. 0554 1778

testo 580 with USB interface

Part no. 0554 1764

testo 581 alarm signal output

- Transmission of alarm messages – e.g. when programmed limit values in the data logger are exceeded – to external components such as horns, lamps, PLC etc.
- Signal transfer via floating signal output



Alarm signal output for reliable notification of limits exceeded

Part no. 0554 1769

Ethernet adapter

- Fast transfer of readings
- Use of an existing network without additional cabling
- Long transmission paths
- Identification of measuring instruments in system network
- In connection with ComSoft 3



Read out the data stored in the logger via the PC network using the Ethernet adapter

Part no. 0554 1711

Printer and Accessories	Part no.
Fast testo 575 printer, incl. 1 roll of thermal paper and batteries, infrared thermal line printer with graphics function	0554 1775
Spare thermal paper for printer (6 rolls)	0554 0569
Spare thermal paper for printer (6 rolls), measurement data documentation legible for up to 10 years	0554 0568
Label thermal paper (Testo patent) for testo 575 printer (6 rolls), can be applied directly	0554 0561
Additional Accessories	Part no.
testo 580 data collector set with RS232, readout holders included, for testo 175/177 data loggers	0554 1778
testo 580 data collector set with USB, readout holders included, for testo 175/177 data loggers	0554 1764
testo 581 alarm signal output, floating, for testo 175/177, forwards information efficiently when limits are exceeded to e.g. horns, lamps, PLC etc.	0554 1769
Battery, 3.6 V/0.8 Ah 1/2 AA, for testo 175-T3/175-H1/175-H2/175-S1	0515 0175
Battery, 3.6 V/1.9 Ah 1AA, for testo 175-T1/175-T2 and all testo 177 loggers	0515 0177
Transport and Protection	Part no.
Lock for wall holder for testo 175/177 data loggers	0554 1755
Transport case for up to 6 testo 177 data loggers, testo 575 printer, testo 580 data collector and accessories	0516 1770
Accessories for humidity probes	Part no.
testo saline pots for control and humidity adjustment of humidity probes, 11.3 %RH and 75.3 %RH with adapter for humidity probe	0554 0660
Metal protection cage, Ø 12 mm for humidity probes, for measurement in flow velocities of less than 10 m/s	0554 0755
Cap with wire mesh filter, Ø 12 mm	0554 0757
Sintered PTFE filter, Ø 12 mm, for corrosive media, High humidity range (long-term measurements), high flow velocities.	0554 0756
Stainless steel sintered cap, Ø 12 mm, is screwed onto humidity probe, for measurements at higher flow velocities or in contaminated air	0554 0647

Software and Accessories	Part no.
For testo 175: ComSoft 4 Set - Basic with RS 232 interface, Basic software with diagram and table function, incl. desk-top holder, PC connection cable	0554 1759
For testo 175: ComSoft 4 Set - Basic with USB interface, Basic software with diagram and table function, incl. desk-top holders, PC connection cable	0554 1766
For testo 177: ComSoft 4 Set - Basic with RS 232 interface, Basic software with diagram and table function, incl. desk-top holder, PC connection cable	0554 1774
For testo 177: ComSoft 4 Set - Basic with USB interface, Basic software with diagram and table function, incl. desk-top holders, PC connection cable	0554 1767
ComSoft 3 - Professional with data management, incl. database, analysis and graphics function, data analysis, trend curve (without interface)	0554 0830
ComSoft 3 - For requirements to CFR 21 Part 11, incl. database, analysis and graphics function, data analysis, trend curve (w/o interface)	0554 0821
RS232 interface for testo 175/177 incl. desk-top holders, PC connection cable, (please also order for ComSoft 3 - Professional)	0554 1757
USB interface, for testo 175/177 incl. desk-top holders, PC conn. cable, (Please order with ComSoft 3 - Professional)	0554 1768
Ethernet adapter, RS232 - Ethernet incl. software driver, mains unit, facilitates data communication in network	0554 1711
Calibration Certificates	Part no.
ISO calibration certificate/temperature, temperature probe; calibration points -18°C; 0°C; +60°C per channel/instrument	0520 0151
ISO calibration certificate/temperature, temp. data logger; calibration points -8°C; 0°C; +40°C per channel/instrument	0520 0171
ISO calibration certificate humidity, calibration points 11.3 %RH and 75.3 %RH at +25 °C/+77 °F; per channel/instrument	0520 0076
DKD calibration certificate/temperature, Temperature probe; cal. points -20°C; 0°C; +60°C (-4 °F, 92 °F, 140 °F); per channel/instrument	0520 0261
DKD calibration cert./humidity, humidity data logger; cal. points 11.3%RH and 75.3%RH at +25°C; per channel/instrument	0520 0246

The "old reliable" — In full-metal housing

testostor 171-0

A temperature data logger in full-metal housing with integrated temperature probe. A long life is guaranteed even in tough conditions.

The data is read out to a PC via the attachable interface.

- Logs up to 55000 readings
- Tamperproof readings
- Theft-proof mounting
- Waterproof, robust metal housing, IP 68
- On site application: Testo Software for Palm OS® replaces laptop/PC



testostor 171-0 monitors fluctuations in temperature constantly

testostor 171-0

Internal °C

testostor 171-0, temperature data logger, incl. starting magnet, battery and calibration protocol; calibration certificates (ISO/DKD) must be ordered separately

Part no. 0577 1719

Additional Accessories and Spare Parts	Part no.	Technical data
Spare battery for testostor 171, quick and easy battery replacement	0515 0018	Meas. range -35 to +70 °C
Transport and Protection	Part no.	Accuracy ±0.5 °C (-35 to +39.9 °C) ±1 digit ±0.6 °C (+40 to +70 °C)
Holder with lock for data logger, theft-proof	0554 1782	Resolution 0.1 °C
Transport case (plastic) for measurement data storage instruments (max. 6 off) and accessories, for safe transport	0516 0117	Material/Housing Aluminium, anodized
PC Software and Accessories	Part no.	Protection class IP68
ComSoft 3 - Professional with data management, incl. database, analysis and graphics function, data analysis, trend curve	0554 0830	Memory 55000
ComSoft 3 - For requirements to CFR 21 Part 11, incl. database, analysis and graphics function, data analysis, trend curve (w/o interface)	0554 0821	Oper. temp. -35 to +70 °C
Interface, attachable to data logger	0554 1781	Storage temp. -40 to +85 °C
Ethernet adapter, RS232 - Ethernet incl. software driver, mains unit, facilitates data communication in network	0554 1711	Dimensions 131 x 68 x 26 mm
Calibration Certificates	Part no.	Weight 305 g
ISO calibration certificate/temperature, temperature probe; calibration points -18°C; 0°C; +60°C per channel/instrument	0520 0151	Battery life: lithium battery up to 5 years
DKD calibration certificate/temperature, Temperature probe; cal. points -20°C; 0°C; +60°C (-4 °F, 92 °F, 140 °F); per channel/instrument	0520 0261	Software: menu-driven from Microsoft Windows 95 / ME / 2000 / XP / Vista
ISO calibration certificate/temperature, temp. data logger; calibration points -8°C; 0°C; +40°C per channel/instrument	0520 0171	

The "old reliable" – With external probes

testostor 171-1

You can place the testostor 171-1 data logger beside the goods, for example, and attach the external probe to doors or refrigeration appliances located up to 12m away. Air moisture can also be monitored, if required.

- Logs up to 55000 readings
- Probe can be positioned quickly and easily
- Tamperproof measurement results
- On site application: Testo Software for Palm OS® replaces laptop/PC



testostor 171-1, external probe socket can be positioned at up to 12m away

testostor 171-4

testostor 171-4 with up to 4 external temperature probe sockets is used for simultaneous temperature measurement at different locations.



Data analysis on your PC/Notebook with easy-to-use Windows® Software

Monitor several refrigerated storerooms using testostor 171-4

testostor 171-1

Int.: °C + Ext.: °C or %RH/°C

testostor 171-1, temperature data logger with °C/%RH probe connection, incl. starting magnet, battery and calibration protocol; calibration certificates (ISO/DKD) must be ordered separately

Part no. 0577 1715

testostor 171-4

4 x external °C

testostor 171-4, temperature data logger, 4 channels, with starting magnet, battery and calibration protocol; calibration certificates (ISO/DKD) must be ordered separately

Part no. 0577 1714

Description	Illustration	Meas. range	Accuracy	Reaction time	Part no.
Robust immersion/air probe, quick-action, 6m cable, IP68 probe tip	40 mm Ø 3 mm	-50 to +80 °C	±0.2 °C (-25 to +80 °C) ±0.4 °C (-50 to -25.1 °C)	5 s <i>t</i> ₉₉ (in water)	0610 1720 Conn.: Fixed cable
Air probe, highly accurate, can be attached directly	30 mm Ø 3 mm	-35 to +70 °C	±0.2 °C (-35 to +70 °C)	180 s ,90	0610 1722
Robust, accurate, waterproof food probe (IP65), made of stainless steel	125 mm Ø 4 mm Ø 3 mm	-50 to +120 °C	±0.2 °C (-25 to +80 °C) ±0.4 °C (-50 to -25.1 °C) ±0.5 °C (+80.1 to +120 °C)	10 s <i>t</i> ₉₉ (in water)	0610 2217 Conn.: Fixed cable
Humidity/temperature probe with standard plastic protection cap	180 mm Ø 12 mm	0 to +100 %RH -20 to +70 °C	±2 %RH (+2 to +98 %RH) ±0.4 °C (-10 to +50 °C) ±0.5 °C (remaining range)	12 s ,90	0636 9717*

*Humidity/temperature probes only for testostor 171-1

Common Technical Data

Chann. external (var.)

Probe type NTC

Meas. range -50 to +120 °C

Accuracy ±0.2 °C (-34.9 to +39.9 °C)
±1 digit ±0.4 °C (+40 to +120 °C)
±0.6 °C (-50 to -35 °C)

Resolution 0.1 °C

Oper. temp. -35 to +70 °C

Storage temp. -40 to +85 °C

Battery type Lithium battery

Memory 55000

Dimensions 131 x 68 x 26 mm

Weight 305 g

Meas. rate: 2 s to 24 h, selectable

Battery life: up to 5 years with lithium battery

Software: menu-driven from Microsoft Windows 95 / ME / 2000 / XP / Vista

testostor 171-1

Chann. intern

Probe type NTC

Meas. range -35 to +70 °C

Accuracy ±0.2 °C (-35 to +39.9 °C)
±1 digit ±0.4 °C (+40 to +70 °C)

Resolution 0.1 °C

Chann. external (var.)

Probe type Testo humid. sensor, cap.

Meas. range 0 to +100 %RH

Accuracy ±2 %RH (+2 to +98 %RH)
±1 digit

Resolution 0.1 %RH

See opposite page for Accessories Ordering data

Electronic thermohygrograph in full-metal housing

testostor 171-3

testostor 171-3, a compact data logger with built-in humidity/temperature probe.

The saved data can be documented on site on the Testo printer or can be analysed on your PC via interface and software.

- Suitable for outdoor use
- Control and adjustment option using adjustment set
- Logs up to 20000 readings
- Measuring rate: 2 s to 24 h, selectable
- Sintered cap protection for dusty environments (see Accessories)
- On site application: Testo Software for Palm OS® replaces laptop/PC



Monitors humidity and temperature in storage rooms

testostor 171-3

Internal %RH/°C

testostor 171-3, humidity data logger for %RH, °C with starting magnet, battery and calibration protocol; calibration certificates (ISO/DKD) must be ordered separately

Part no. 0577 1713

Set 1: Without display

Set testostor 171-3, incl. humidity data logger for %RH, °C with starting magnet, battery, calibration protocol and software with interface; calibration certificates (ISO/DKD) must be ordered separately

Part no. 0563 1713

Further accessories and spare parts

	Part no.
Spare battery for testostor 171, quick and easy battery replacement	0515 0018
testo saline pots for control and humidity adjustment of humidity probes, 11.3 %RH and 75.3 %RH with adapter for humidity probe	0554 0660
Stainless steel sintered cap, Ø 21 mm, can be screwed onto humidity probe	0554 0640

Transport and protection

	Part no.
Holder with lock for data logger, theft-proof	0554 1782
Transport case (plastic) for measurement data storage instruments (max. 6 off) and accessories, for safe transport	0516 0117

PC software and accessories

	Part no.
ComSoft 3 - Professional with data management, incl. database, analysis and graphics function, data analysis, trend curve	0554 0830
ComSoft 3 - For requirements to CFR 21 Part 11, incl. database, analysis and graphics function, data analysis, trend curve (w/o interface)	0554 0821
Interface, attachable to data logger	0554 1781
Ethernet adapter, RS232 - Ethernet incl. software driver, mains unit, facilitates data communication in network	0554 1711

Calibration Certificates

	Part no.
DKD calibration cert./humidity, humidity data logger; cal. points 11.3%RH and 75.3%RH at +25°C; per channel/instrument	0520 0246
ISO calibration certificate humidity, calibration points 11.3 %RH and 75.3 %RH at +25 °C/+77 °F; per channel/instrument	0520 0076
ISO calibration certificate/temperature, temp. data logger; calibration points -8°C; 0°C; +40°C per channel/instrument	0520 0171

Assurance when purchasing

"Often, interested customers do not even expect a visit from me following consultation by telephone. If a customer then gets to see the instrument, it gives him maximum assurance when making the decision to purchase."



Uwe Becker
Head of Customer Center, Southwest Germany

Recommended Set: The practical set in the case

Set testostor 171-3, incl. humidity data logger for %RH, °C with starting magnet, battery, calibration protocol and software with interface; calibration certificates (ISO/DKD) must be ordered separately	0563 1713
Transport case (plastic) for measurement data storage instruments (max. 6 off) and accessories, for safe transport	0516 0117

Technical data

Meas. range	-10 to +50 °C
Accuracy	±0.5 °C (-10 to +39.9 °C)
±1 digit	±0.6 °C (+40 to +50 °C)
Resolution	0.1 °C
Material/Housing	Aluminium, anodized
Protection class	IP65
Memory	20000
Oper. temp.	-20 to +70 °C
Storage temp.	-40 to +85 °C
Dimensions	131 x 68 x 84 mm
Weight	320 g
Measuring rate: 2 s to 24 h, selectable	
Battery life: up to 5 years	
Software: menu-driven from Microsoft Windows 95 / ME / 2000 / XP / Vista	

Measuring cooking oil quality – quickly and accurately

testo 270

The cooking oil has been frequently used. Longer use is bad for the quality of the product and can lead to complaints from the customer.

The most important part of the testo 270 cooking oil tester is Testo's new capacitive oil sensor. Using this sensor, measurements are carried out directly in the hot cooking oil which means that control measurements can be quickly carried out while work in the kitchen is in progress. Several deep-fat fryers can be tested back-to-back without the sensor having to cool down.

Maximum use of the cooking oil is made possible. The oil is only changed if the limit value is reached.

- Measurement directly in the deep-fryer
- Sensor is embedded in metal and breakage-proof, can be easily wiped clean thanks to sensor protection layer
- Fast measurement value display in % TPM
- Automatic recognition of measurement end (Auto-Hold %TPM)
- With 2 freely selectable limit values
- Alarm function audible and visual:
 - Lettering "ALARM"
 - 3-colour LED bar (green, yellow, red)
- Configuration menu and limit values can be locked to protect them from external manipulation
- Removable protective case and optional hand strap (dishwasher-proof)
- Conforms to: VO (EG) 1935/2004, EC guideline 2004/108/EC

2-line display with alarm for limit value violations

Breakage-proof, maintenance-free and easy-to-clean sensor with sensor protection layer



Monitoring cooking oil in a deep-fryer



Washable protective case TopSafe included in delivery



testo 270, set in aluminium case incl. reference oil for monitoring accuracy

Technical data

Measurement parameters	Total Polar Materials (%TPM) Temperature (°C/°F)
Measurement value sensor	Capacitive Testo sensor (%TPM) PTC (°C/°F)
Meas. range	0,5 to 40,0 %TPM +40 to +200 °C
Accuracy	±2 %TPM (+40 to +190 °C) (at ambient temperature of +25 °C) ±1,5 °C
Resolution	0,5 %TPM 0,5 °C/°F
Cooking oil temperature	+40 to +200 °C
Storage temp.	-20 to +70 °C
Oper. temp.	0 to +50 °C
Dimensions	Approx. 354 x 50 x 30 mm (incl. TopSafe)
Weight	Approx. 164 g (incl. batteries, TopSafe, hand strap)
Display	LCD, 2-line, display illumination
Battery type	2 x AA
Battery life	approx. 25 h continuous use approx. 500 measurements
Material/Housing	ABS (white) TopSafe as accessory (included)
Alarm function (can be switched off)	2 limit values freely adjustable, 3-colour LED (green, yellow, red), audible alarm when temperature and limit values are violated or at end of measurement (Auto-Hold)
Further displays	Maximum measuring temperature exceeded Minimum measuring temperature exceeded
Miscellaneous	Response time TPM < 30 sec. (Prerequisite: measurement value is within accuracy limits) Protection class (with TopSafe) IP 65 Warranty 24 months

testo 270, set in a case

Cooking oil tester testo 270 incl. aluminium case, TopSafe, hand strap, reference oil, batteries, adjustment protocol, instruction manual and short instruction manual

Part no. 0563 2700

Accessories Ordering data

Accessories Ordering data	Part no.
ISO calibration certificate/analysis, calibration points 3 % TPM and 24 %TPM at 50 °C	0520 0028
Reference oil for calibrating and adjusting the cooking oil tester testo 265 (1 x 100 ml)	0554 2650
Reference oil for calibrating and adjusting the cooking oil tester testo 265 (3 x 100ml)	0554 2651

Compact pH tester – For liquids

testo 206 pH1

The pH measuring instrument for fast checks on liquids. The combination of pH immersion tip and temperature probe for fast and efficient temperature compensation is unique.

The Testo pH probe is leak-proof, maintenance-free, robust and not affected by dirt thanks to the large volume of gel electrolyte and the dual wall diaphragm.

- Maintenance-free gel electrolyte
- Built-in temperature probe
- 1, 2 or 3 point calibration possible

pH1 probe head for liquids

TopSafe, protection case (included)

Fast pH check on fruit juices, for example

testo 206-pH1 instrument set

One-hand pH/°C measuring instrument, pH1 probe head for liquids, storage cap with gel, TopSafe and belt/wall holder

Part no. 0563 2061

testo 206-pH1 Starter Set

One-hand pH/°C measuring instrument, pH1 probe head for liquids, storage cap with gel, calibration dosing bottles 250 ml pH 4+7, TopSafe, belt/wall holder and aluminium case

Part no. 0563 2065

Ordering data as for testo 206-pH2, see below

Technical data

Sensor	pH electrode	NTC
Meas. range	0 to 14 pH	0 to 60 °C (Short-term to +80 °C max. 5 min)
Accuracy ±1 digit	±0.02 pH	±0.4 °C
Resolution	0.01 pH	0.1 °C
Storage temp.	-20 to +70 °C	Oper. temp. 0 to +60 °C
Compensation	Automatic temperature compensation	
Measuring rate	2 measurements per second	
Battery life	80 h (Auto Off 10 min)	Dimensions 197 x 33 x 20 mm

Compact pH tester – For semi-solid food

testo 206-pH2

The pH measuring instrument for spot checks on semi-solid food, e.g. jelly, cream, cheese, fruit...

The protection case included "TopSafe" (IP 68) is waterproof, hygienic and dishwasher-safe.

- Can be used for food containing protein
- Combination: pH penetration tip with temperature measurement probe
- Automatic full scale value

pH2 probe head for semi-solid food

Leak-proof storage gel

Spot pH checks on milk products

testo 206-pH2 instrument set

One-hand pH/°C measuring instrument, pH2 probe head for semi-solid substances, storage cap with gel, TopSafe and belt/wall holder

Part no. 0563 2062

testo 206-pH2 Starter Set

One-hand pH/°C measuring instrument, pH2 probe head for semi-solid substances, storage cap with gel, calibration dosing bottles 250 ml pH 4+7, TopSafe, belt/wall holder and aluminium case

Part no. 0563 2066

Accessories Ordering data

Part no.

Spare pH probe for testo 206 incl. gel storage cap	0650 2061
Spare pH probe pH2 for testo 206 incl. gel storage cap	0650 2062
Storage cap for testo 206 with KCl gel filling	0554 2067
Storage cap for testo 206 with KCl gel filling (pack of 3)	0554 2068
pH buffer solution 4.01 in dosing bottle (250 ml), with DKD calibration certificate	0554 2061
pH buffer solution 4.01 in dosing bottle (3 x 250 ml per pack), with DKD calibration certificate	0554 2062

Accessories Ordering data

Part no.

pH buffer solution 7.00 in dosing bottle (250 ml), with DKD calibration certificate	0554 2063
pH buffer solution 7.00 in dosing bottle (3 x 250 ml per pack), with DKD calibration certificate	0554 2064
pH buffer solution 10.01 in dosing bottle (250 ml), with DKD calibration certificate	0554 2065
pH buffer solution 10.01 in dosing bottle (3 x 250 ml per pack), with DKD calibration certificate	0554 2066

Technical data as for testo 206-pH1, see above

Accessories: Buffer solutions for testo 205/206/230

Testo buffer solutions with pH 4.01/7.00/10.01

pH buffer solution 4.01 in dosing bottle (250 ml), with DKD calibration certificate

Part no. 0554 2061

pH buffer solution 7.00 in dosing bottle (250 ml), with DKD calibration certificate

Part no. 0554 2063

pH buffer solution 10.01 in dosing bottle (250 ml), with DKD calibration certificate

Part no. 0554 2065



1 Filling the dosing chamber

- To attain the right buffer quantity



2 Adjusting

- Instrument adjustment in fresh pH buffer solution, no measurement errors caused by used buffer solution



3 Emptying the dosing chamber

- Empty dosing chamber following adjustment, i.e. no contamination caused by left over buffer solution



One-hand pH/°C measuring instrument – Robust and maintenance-free

testo 205

A robust food penetration pH/°C measuring instrument with automatic temperature compensation. The robust penetration measuring tip is interchangeable and not affected by dirt and dust thanks to the hole diaphragm.

- Combined penetration tip with temperature probe
- Measuring tip can be changed by user
- Maintenance-free gel electrolyte
- Backlit display
- Audible key feedback
- 2 line display
- Automatic full-scale value recognition
- 1, 2 or 3 point calibration possible



pH tip embedded in unbreakable plastic



Constant quality control when storing food



Instruments Set

One-hand pH/°C measuring instrument with penetration probe, storage cap, belt/wall holder

Part no. 0563 2051

Starter Set

One-hand pH/°C meas. instr. with penetration probe, storage cap, gel and cal. bottles 250 ml pH 4+7, belt/wall holder and aluminium case

Part no. 0563 2052

Accessories Ordering data

Part no.

Spare pH probe for testo 205 with gel storage cap 0650 2051

Storage cap for testo 205 with KCL gel filling 0554 2051

Aluminium case for pH measuring instruments testo 205/206 and accessories 0554 2069

Technical data

Sensor	pH electrode	NTC
Meas. range	0 to 14 pH	0 to 60 °C (Short-term to +80 °C max. 5 min)
Accuracy ±1 digit	±0.02 pH	±0.4 °C
Resolution	0.01 pH	0.1 °C
Battery type	4 x Button cell LR44	Oper. temp. 0 to +50 °C
Auto Off	10 min	Storage temp. -20 to +70 °C



Compact pH/°C measuring instrument – With selection of probes

testo 230

A complete pH measuring instrument and a high standard thermometer in a compact, water-proof (IP54) housing.

- Probes for liquid, semisolid and solid food
- Display of calibration data and error messages

testo 230

Analysis instrument, incl. 2 electrode clips and battery

Part no. 0560 2304

The set for solid/semisolid food

Analysis instrument, incl. 2 electrode clips, battery, Testo buffer set pH 4/7 (50 ml each), robust penetration electrode type 13 pH, storage solution (50 ml), robust food penetration probe, transport case (plastic)

Part no. 0563 2308

testo 230, Food Set

testo 230, Food set: testo 230 analysis instrument with 2 electrode clips and battery, Testo buffer set pH 4 and 7, 50ml each, penetration electrode Type 03 pH, storage solution (50ml), connection cable (1m), food probe made of stainless steel (IP 65) and plastic set case

Part no. 0563 2306

pH probes and temperature probes can be connected



Checks pH value and penetration temperature in meat prior to further processing

Accessories Ordering data	Part no.
Set case (plastic) for measuring instrument, probes and accessories, user-friendly arrangement of measuring instrument and accessories	0516 0230
Connection cable for electrodes with plug-in head, 1m long, S7-BNC plug-in connection	0554 2317
Testo buffer set pH 4, 7; 50 ml each, for calibration in acidic range	0554 2321
Testo buffer set pH 4, 7, 10; 50ml each, for calibration in acidic and alkaline range	0554 2320
Storage solution (refill solution for electrode type 02 pH), 50 ml, for electrodes type 01 pH, 02 pH, 04 pH, 06 mV	0554 2332
Storage solution; 50ml, for electrode type 03 pH and type 13 pH	0554 2318
Storage and refill solution; 50ml, for electrode type 05 pH	0554 2319
Redox standard 358 mV, 50ml	0554 2333
Gel storage cap for standard electrodes	0554 2053
ISO calibration certificate/water analysis, for pH buffer solutions; calibration points 4 pH; 7 pH; 10 pH	0520 0007
ISO calibration certificate/water analysis, at 3 pH values over the measuring range	0520 0037

Technical data			
Probe type	pH electrode	NTC	Redox electrode
Meas. range	0 to +14 pH	-50 to +150 °C	-1999 to +1999 mV
Accuracy ±1 digit	±0.01 pH (0 to +14 pH)	±0.5% of mv (+100 to +150 °C) ±0.2 °C (-25 to +74.9 °C) ±0.4 °C (-50 to -25.1 °C) ±0.4 °C (+75 to +99.9 °C)	±1 mV (-999 to 0 mV) ±1 mV (0 to +999 mV) ±2 mV (-1999 to -1000 mV) ±2 mV (+1000 to +1999 mV)
Resolution	0.01 pH	0.1 °C	1 mV
Oper. temp.	0 to +40 °C	Battery life	100 h
Storage temp.	-20 to +70 °C	Dimensions	168 x 72 x 27 mm
Display	LCD, 2 lines	Weight	170 g
Battery type	9V block battery	Material/Housing	ABS
Temperature compensation: man. -10 to +150°C; auto -50 to +150°C			

Description	Illustration	Meas. range	Oper. temp. Accuracy	Part no.
Universal electrode type 01 pH: affordable, indestructible plastic electrode with gel electrolyte, thus practically maintenance-free, with gel storage cap	120 mm Ø 12 mm	0 to +14 pH	0 to +60 °C Short-term to +80 °C	0650 0623 Conn.: Fixed cable with BNC
Type 14: indestructible plastic electrode with temperature sensor, gel electrolyte, therefore practically maintenance-free, with gel storage cap	135 mm Ø 12 mm	0 to +14 pH 0 to +60 °C	0 to +60 °C	0650 2064 Conn.: Fixed cable with BNC
Penetration electrode type 03 pH: highly accurate glass electrode with solidified electrolyte suitable for use in food. Not affected by dirt due to hole diaphragm. Incl. ground sleeve adapter and immersion cap.	100 mm 35 mm Ø 6 mm Conn.: Plug-in head, connection cable 0554 2317 or 0554 2314 required	+2 to +14 pH	0 to +40 °C Short-term to +60 °C	0650 0225
Robust penetration electrode type 13 pH: for solid or semi-solid foodstuff with break-proof plastic coating around the glass electrode and food-safe electrolyte. Not affected by dirt thanks to hole diaphragm. Incl. immersion cap	95 mm	+2 to +14 pH	0 to +40 °C	0650 0245 Conn.: Fixed cable with BNC
Robust NTC food penetration probe with special handle, reinforced PUR cable	115 mm Ø 5 mm 30 mm Ø 3.5 mm	-25 to +150 °C Long-term meas. range +125 °C, short-term +150 °C (2 minutes)	±0.5% of mv (+100 to +150 °C) ±0.2 °C (-25 to +74.9 °C) ±0.4 °C (remaining range)	0613 2411 Conn.: Fixed cable

See testo 110 for temperature probes (except wireless probes)

Compact conductivity/°C measuring instrument – With range of probes

testo 240

testo 240 is a complete conductivity measuring instrument and a high standard thermometer combined in one compact, waterproof housing.

Measurement errors caused by high conductivities and deposits on the electrodes are avoided thanks to the 4 electrode engineering used. The salt level (NaCl) in an aqueous solution can be measured directly.

- Long life of measurement cell thanks to 4 electrode engineering
- Extremely wide measurement ranges with only one measurement cell

Conductivity and temperature measurement instrument in one



Measuring salt level (NaCl) in pickling brine

Versatile Set 1, Better value in set

testo 240 conductivity and temperature measuring instrument, battery, 2 electrode clips, versatile conductivity measurement cell, case (plastic)

Part no. 0563 2405

Precision Set 2, Better value in set

testo 240 conductivity and temperature measuring instrument, battery, 2 electrode clips, precision conductivity measurement cell, case (plastic)

Part no. 0563 2406

testo 240

Conductivity and temperature measuring instrument incl. battery and 2 electrode clips

Part no. 0560 2404

Technical data			
Probe type	Conductivity measuring cell	NTC	Calc. parameter
Meas. range	0 to +2000 mS/cm	-50 to +150 °C	1 mg/l to 200 g/l NaCl
Accuracy ±1 digit	±1% of mv (0 to +2000 mS/cm)	±0.5% of mv (+100 to +150 °C) ±0.2 °C (-25 to +74.9 °C) ±0.4 °C (remaining range)	±1.2% of mv (1 mg/l to 200 g/l NaCl)
Resolution		0.1 °C	0.1 mg/l NaCl
Oper. temp.	0 to +40 °C	Dimensions	168 x 72 x 27 mm
Storage temp.	-20 to +70 °C	Weight	170 g
Battery life	60 h	Protection class	IP54
Resolution max. 0.1 µS/cm; temperature compensation automatic; temperature coefficient: 0 to 5 %/°C linear; compensation in accordance with non-linear function of natural water to DIN 38404 from 0...+50°C; autom. measurement range switchover (conductivity); Auto OFF function; switch between °C/°F			

Accessories Ordering data	Part no.
Conductivity standard (1413 µS/cm), 0.01 mol/l KCL, to calibrate conductivity measuring cells	0554 2334
Set case (plastic) for measuring instrument, probes and accessories, user-friendly arrangement of measuring instrument and accessories	0516 0230
ISO calibration certificate/analysis, for conductivity solutions; calibration point 1.413 mS/cm	0520 0019
ISO calibration certificate/temperature, for air/immersion probes, calibration points -18°C; 0°C; +60°C	0520 0001
ISO calibration certificate/analysis, at 3 conductivity values over the measuring range	0520 0049

Description	Illustration	Meas. range	Other features	Part no.
Universal conductivity measuring cell, type 07 mS, highest accuracy up to 200 mS/cm, stainless steel	130 mm Ø 20 mm	+0.001 to +200 mS/cm 0 to +60 °C	4 electrode engineering with built-in temperature sensor	0650 3023 Conn.: Fixed cable
Precision conductivity measuring cell, type 10 mS, long-term stable, highest accuracy up to 300 mS/cm, graphite	130 mm Ø 20 mm	+0.001 to +300 mS/cm 0 to +60 °C	4 electrode engineering with built-in temperature sensor	0650 3024 Conn.: Fixed cable

Description	Illustration	Meas. range	Accuracy	t99	Part no.
Waterproof NTC immersion/penetration probe	115 mm Ø 5 mm	-50 to +150 °C Long-term meas. range +125 °C, short-term +150 °C (2 minutes)	±0.5% of mv (+100 to +150 °C) ±0.2 °C (-25 to +74.9 °C) ±0.4 °C (remaining range)	10 s	0613 1212 Conn.: Fixed cable
Laboratory probe, glass-coated, resistant to corrosive substances, glass stem can be replaced	200 mm Ø 6 mm	-50 to +150 °C Long-term meas. range +125 °C, short-term +150 °C (2 minutes)	±0.5% of mv (+100 to +150 °C) ±0.2 °C (-25 to +74.9 °C) ±0.4 °C (remaining range)	40 s 10 s*	0613 7011 Conn.: Fixed cable
Stainless steel NTC food probe (IP65) with PUR cable	125 mm Ø 4 mm	-50 to +150 °C Long-term meas. range +125 °C, short-term +150 °C (2 minutes)	±0.5% of mv (+100 to +150 °C) ±0.2 °C (-25 to +74.9 °C) ±0.4 °C (remaining range)	8 s	0613 2211 Conn.: Fixed cable
Waterproof NTC surface probe for flat surfaces	115 mm Ø 5 mm	-50 to +150 °C Long-term meas. range +125 °C, short-term +150 °C (2 minutes)	±0.5% of mv (+100 to +150 °C) ±0.2 °C (-25 to +74.9 °C) ±0.4 °C (remaining range)		0613 1912 Conn.: Fixed cable

See testo 110 for more temperature probes (except wireless probes)

* without protective glass



Notes

Notes



Testo: At Your Service

Please send for more information:

Monitoring Instruments for Food Production, Transport and Storage
Measurement Engineering for Restaurants, Catering and Supermarkets
Measurement Engineering for Air Conditioning and Ventilation
Measurement Engineering for Heating and Installation
Measurement Solutions for Emissions, Service and Thermal Processes
Measurement Solutions for Refrigeration Technology
Stationary Measurement Solutions for Air Conditioning, Drying, Cleanrooms and Compressed Air
Measurement Solutions for Production, Quality Control and Maintenance
Measurement Solutions for Climate Applications in Industry
Reference Measurement Technology for Industry

Measuring Instruments For Temperature
Measuring Instruments for Humidity
Measuring Instruments For Velocity
Measuring Instruments for Pressure and Refrigeration
Multi-Function Measuring Instruments
Measuring Instruments for Flue Gas and Emissions
Measuring Instruments for RPM, Analysis, Current/Voltage
Measuring Instruments For Indoor Air Quality, Light And Sound
Stationary Measurement Technology Humidity / Differential Pressure / Temperature / Process Displays
Stationary Measurement Technology Compressed Air Humidity / Compressed Air Consumption

Subject to change without notice.

0981 1024/msp/SI/A/01.2010



Contents

	Page
Temperature	
Mini thermometer	Temperature measurement – Fast and easy 6/7
testo 905-T1/-T2	Temperature measurement – Accurate and fast-action 6
testo 605	Measures ambient conditions – flexible and easy 7
testo 106	Core thermometer – fast and robust 9
testo 105	Robust one-hand thermometer 9
Mini thermometer	Mini thermometer – With penetration probe 10
	Temperature clock indicators 10
	Temperature strips 11
	Temperature single indicators 11
testo 110	Temperature monitoring – Highly accurate 12
testo 112	Calibratable temperature measuring instrument – Highly accurate 14
testo 926	Fast, accurate all-round thermometer 16
testo 925	Spot check thermometer – Fast and reliable 20
testo 735-2	Highly accurate alarm and logger thermometer 22
testo 950	Reference measuring instrument 26
testo 805	Mini infrared thermometer 27
testo 826-T1/-T2	Temperature measurement – Non-contact 28
testo 826-T3/-T4	Temperature measurement – Non-contact or direct 28
testo 831	Distance thermometer for infrared monitoring measurements 29
testo 845	The infrared measurement technology 30
Monitoring-System	
testo Saveris™	Central measurement data monitoring 32
<i>Data loggers</i>	
testo 174	Monitors storage temperature 43
testo 175-T1	Documents storage temperature 43
testo 175-T2	Logs temperature 44
testo 177-T1/-T2	Long-term temperature monitoring 46
testo 177-T3	The data logger for trucks 47
testostor 171-0	The „old-reliables“ – in full-metal housing 50
testostor 171-1/-4	The „old-reliables“ – with external probes 51
testostor 171-3	Electronic thermohygrograph in full-metal housing 52
Humidity	
testo 608-H1/-H2	Monitors ambient storage conditions 27
<i>Data loggers</i>	
testo 175-H1/-H2	Monitors ambient storage conditions 45
testo 177-H1	Long-term monitoring of ambient conditions 48
Analysis	
testo 206-pH1	Compact pH tester – For liquids 54
testo 206-pH2	Compact pH tester – For semi-solid food 54
testo 205	One-hand pH/°C-measuring instrument 55
testo 230	Compact pH/°C measuring instrument – With selection of probes 56
testo 240	Compact conductivity-/°C-measuring instrument 57
Additional parameters	
testo 270	Measures cooking oil quality 53

Icons



Backlit display



User-friendly operation based on menu-driven operations



Radio probes for wireless applications



SoftCase or TopSafe to protect instrument or protect instrument from water ingress



Shock-proof



Infrared printer
Efficient paper documentation of measured results on site



RS 232/USB interface
For easy connection to analysis software



Battery and rechargeable battery operation possible



Battery can be recharged in instrument



Testo is a member of Eurotoques, the Association for top chefs with the aim of retaining, promoting and spreading the culture of cooking, eating, drinking, culinary diversity, quality awareness and healthy nutrition using natural ingredients.